



**ఆంధ్ర ప్రగతి గ్రామీణ బ్యాంక్**  
**ANDHRA PRAGATHI GRAMEENA BANK**

COMMITTED TO RURAL DEVELOPMENT

గ్రామీణాభివృద్ధి ధ్యేయం

ప్రభుత్వరంగ ఏరియాల్డ్ బ్యాంక్

కెనరా బ్యాంక్ సొజన్సియంట్

A SCHEDULED GOVERNMENT BANK  
(Sponsored by CANARA BANK)

HEAD OFFICE : KADAPA (AP)

Ref No: 443/APGB/VNPALLI/23

Date: 08.12.2023

TENDER  
DOCUMENT  
FOR

**“Demolition and Re Construction of Branch Building at V N  
Palli Village  
(Kadapa District)”**

Issued by

**Premises Maintenance & Services Department,  
ANDHRA PRAGATHI GRAMEENA BANK,  
HEAD OFFICE, KADAPA**

Phone: 9490158007 E-mail: [hopms@apgb.in](mailto:hopms@apgb.in)

In case of any technical clarification,  
Contact the Bank's Engineering Consultant

**Sri. Y K Ravi Teja Reddy, Mob: 9704024266  
Email: [yk.ravitejareddy@gmail.com](mailto:yk.ravitejareddy@gmail.com)**



### **NOTICE INVITING TENDER (N.I.T)**

APG Bank, Head Office, KADAPA invites Sealed tenders on **item rate basis** from APPWD, PUBLIC SECTOR BANKS eligible **CIVIL CONTRACTORS (Class III UP TO 50 lakhs and Class I Up to 100 Lakhs Only)** for the works mentioned below-

1.	Name of the Work	: <b>Demolition and Construction of Branch Building at V N Palli , Kadapa District</b>
2.	Location of Work	: <b>Panchayat, V N Palli</b>
3.	Nature of the document	Two Bid Concept
4.	Contents of the offer document	A. <i>Technical Bid (First envelope)</i> B. <i>Financial Bid (Second envelope)</i>  <b>Technical Bid &amp; Financial Bid to be submitted in Separate envelopes &amp; these 2 separate envelopes shall be enclosed in a single envelope.</b>
5.	Application Fee ( Non Refundable)	<b>Rs. 1,000/-</b> Payable in DD favoring APGB, payable at KADAPA
6.	EMD Amount (to be submitted along with the tender)	: <b>Rs. 30,000/-</b> Payable in DD favoring APGB, payable at KADAPA
7.	Time of Completion/ Project duration	: 270 days from the Day of Acceptance of the Tender by the Bank Including monsoon Period.
8.	Date of Submission	: Sealed envelopes to be submitted on or before <b>"30.12.2023" up to 05:00 PM</b> to the "THE REGIONAL MANAGER, ANDHRA PRAGATHI GRAMEENA BANK, REGIONAL OFFICE, KADAPA.
9.	Time & Date of Opening	: Date and Time will be informed to the participated bidders.

\* 270 days is time of completion of the total project. Civil contractor to coordinate with local Panchayat jurisdiction agencies and all the Civil works in the schedule to be completed within the overall project time of 270 days Including monsoon Period.

The tenders with the rates duly filled in and signed in each page of the tender shall be submitted in sealed cover prescribing the name of work and the due date for opening. The sealed tender must be submitted to Regional Office within the above-stipulated time. The tenders shall be opened in Head Office at the above specified time.

The tenderers/ Authorized representative are requested to be present at the time of opening. **Bank reserves the right to reject any or all the tenders without assigning any reason thereof. Tender's without application fee and EMD shall be summarily rejected.**



**Eligibility Criteria:**

SI.	Criteria	Documents Required
1	The Contractor should have minimum of 7 years' experience in the field of construction of single/multi-storied commercial / institutional buildings with all services as on 30/11/2023.	At least one work Order copy & Completion certificates issued between 01/12/2016 to 30/11/2023.
2	The Contractor should have provided at least: One(1) similar work order and Works Done Certificate costing Rs.50 Lakh of project cost during the last 7(Seven) years ending with 30.11.2023.	At least one work Order & Completion certificate issued between 01/12/2016 to 30/11/2023. Order copies and satisfactory completion certificates clearly indicating the cost& nature of work handled and month & year of commencement & completion.
3	The Contractor must have GST registration number and PAN number	Copies of the registration certificate and PAN card copy shall be enclosed.
4	IT Returns filed for the last 3 years i.e., 2020-21, 2021-22, 2022-23 Profit and Loss Statement Certified By CA	Copies of the IT return filed shall be enclosed.
5	Average Turn over should be over and above Rs. 25 lakh during last 3 years. i.e., 2020-21, 2021-22, 2022-23 Duly Certified By CA	Supporting documents shall be enclosed clearly.
6	The Contractor shall be having an existing running office preferably in & around Kadapa & Anantapur should have executed works in Andhra Pradesh. Regarding firms which doesn't have an office in the above locations, Bank may consider its offer at its discretion.	Copy of the registration Certificate/ Trade license of the office Tobe enclosed.
7	BLACKLISTING / DEBARRED CERTIFICATE Contractors who have been debarred / blacklisted by any of the organization will not be considered.	In this respect, the Bidders shall submit declaration on their Company Letter headed paper duly sealed & signed

**GENERAL MANAGER**

## **GENERAL RULES AND DIRECTIONS TO TENDERERS**

1. The tender/offer is "**TWO ENVELOPE CONCEPTS**" and shall be submitted in two separate sealed envelopes as detailed below:-

The first envelope (**Envelope- 1**) to be super scribed as "**TECHNICAL BID FOR Demolition and Construction of Branch Building at V N Palli, Kadapa District**"

It should contain offer document duly signed in all pages consisting of:

- a. Application Fee as specified in NIT
- b. Earnest Money Deposit as specified in NIT
- c. Eligibility criteria
- d. General Rules & Instructions to the tenderers
- e. Special conditions of the contract
- f. General conditions of the contract
- g. Safety codes
- h. Agreement
- i. Appendix-Time schedule
- j. Approved Brands of Materials
- k. Bills of Quantities

**Note:** Financial aspects of the offer should not be disclosed in any way in the technical bid and such technical bids consisting financial aspects are liable for rejection. Any offer not containing EMD and/or Application Fee as specified shall be summarily rejected. No consideration in such respect shall be entertained.

Offerors shall make note that as per guidelines issued by the Govt of India, all units registered under MSME are exempted from paying Application Fee & Earnest Money Deposit for Government/PSU tenders. All such offerors who are registered as MSME units are hence exempted from paying application fee & Earnest Money. In case any offer or claims exemption from paying such fees, he/she shall mandatorily submit certificate issued by competent authority for such exemption along with application in ENVELOPE - 1. Any application submitted without prescribed fees as well as exemption certificate, shall be summarily rejected. No consideration for same shall be entertained at the time of opening the bids.

The second envelope (**Envelope- 2**) to be super scribed as "**Financial Bid for Demolition and Construction of Branch Building at V N Palli, Kadapa District**".

It should only contain price offer quoting fee for complete services.

No other terms and conditions or information shall be furnished in the financial bid other than the fee. The offeror is requested to refer to the terms and conditions in the draft agreement enclosed while quoting the fees.

These above two envelopes put in an outer envelope (Envelope 3) to be super scribed as "**Offer for Demolition and Construction of Branch Building at V N Palli, Kadapa District**" should be submitted to the address as detailed in Notice Inviting Tenders (NIT).

**All the envelopes are to be duly sealed. Submission of open envelopes shall make the offer liable for rejection.**



2. All work proposed for execution by contract will be notified in a form of Invitation to Tender and signed by the Bank Officer inviting tender.

This form will state the work to be carried out, as well as the date for submitting and opening tenders and the time allowed for carrying out the work, also the amount of Earnest money to be deposited with the tender, and the amount of the security deposit to be deposited by the successful tenderers and the percentage, if any, to be deducted from bills. Copies of the specification, tender drawings and any other documents required in connection with the work signed for the purpose of identification by the officer inviting tender shall also be open for inspection by the contractor at the office of officer inviting tender during office hours.

3. In the event of the tender being submitted by a firm, it must be signed separately by each partner thereof or in the event of the absence of any partner, it must be signed on his behalf by a person holding a power-of-attorney authorizing him to do so, such power of attorney to be produced with the tender, and it must disclose that the firm is duly registered under the Indian Partnership Act 1952 by enclosing a copy of the partnership deed duly certified by one partner as true copy.

Tender by Hindu Joint Family (HUF) firm may be signed by the Kartha or Manager or any other duly authorized representative followed by the name and designation.

4. Receipts for payments made on account of a work, when executed by a firm, shall be in the name of the firm by one of the partners, or by some other person having due authority to give effectual receipts for the firm.
5. Any person who submits a tender shall fill up the printed prescribed form stating what rate he is willing to undertake each item of the work. Tenders, which propose any alteration in the work specified in the same form of invitation to tender, or in the time allowed for carrying out the work, or which contain any other conditions of any sort, will be liable to rejection. No single tender shall include more than one work. Tenders shall have the name and number of the works to which they refer, written on the envelopes. Modifications to specifications, item description, any clauses, conditions or any provisions whatsoever in the tender documents shall lead to disqualification of the tender.

6. **The rate quoted shall comply to the following:**

(a) The rate(s) and/or amount(s) must be quoted in decimal coinage. Amounts must be quoted in full rupees by ignoring fifty paise and less and considering more than fifty paise as rupee one.

(b) In case of illiterate contractors, the rates or the amounts should be attested by a witness, with a declaration that the contents of the tender documents have been explained to the tenderer.

(c) The rate columns should be filled in English figures and English words.

(d) The rate and amount columns for alternative items, if any, shall be filled up but amounts shall not be added in the total. The amount of alternative items of which quantities are not mentioned shall not be filled.

7. In the case of any errors or omissions in the quoted rates, the rates given in the tender marked "Original" shall be taken as correct rates.

All corrections such as cuttings, interpolations, omissions and over-writings shall be numbered as 'c', 'i', 'o' and 'ow' and initialed and total of such c, i, o and ow on each page certified at the end of the page with grand total at the end of the bill / schedule of quantities. Use of correcting fluid, anywhere in tender document is not permitted. Such tender is liable for rejection.



8. The officer inviting tender or his duly authorized assistant will open tenders in the presence of any intending contractors who may be present at the time, and will enter the amounts of the several tenders in a comparative statement in a suitable form. In the event of a tender being accepted for consideration, a receipt for the earnest money forwarded therewith shall thereupon be given to the contractor who shall thereupon for the purpose of identification sign copies of the specifications and other documents mentioned in Rule-I. In the event of a tender being disqualified and rejected, the earnest money forwarded with such unaccepted tender shall thereupon be returned to the contractor remitting the same, without any interest.
9. The Officer inviting tenders shall have the right of rejecting all or any of the tenders and will not be bound to accept the lowest or any one tender.
10. The memorandum of work tendered for and the schedule of materials to be supplied by the Bank and their issue-rates, shall be filled in and completed in the office of the officer inviting tender before the tender form is issued. If a form is issued to an intending tenderers without having been so filled in and completed, he shall request the officer to have this done before he completes and delivers his tender.
11. The Tenderer shall take all necessary precautions to ensure that all confidential information which the Tenderer obtains in the course of participating in this Tender or at any time thereafter is not disclosed or used other than for the purpose of project execution / scope of work / deliverables. Tenderer shall suitably defend, indemnify Bank for any loss / damage suffered by Bank on account of and to the extent of any disclosure of such confidential information. Confidential information for this purpose refers to such information pertaining to Bank provided to Tenderer which is marked as confidential and which is not available in the Public Domain".
12. In the case of item rate tenders, only rates quoted shall be considered. Any tender containing percentage below / above the rates quoted is liable to be rejected. Rates quoted by the contractor in item rate tender in figures and words shall be accurately filled in so that there is no discrepancy in the rates written in figures and words. However, if a discrepancy is found, the rates which correspond with the amount worked out by the contractor shall unless otherwise proved be taken as correct. If the amount of an item is not worked out by the contractor or it does not correspond with the rates written either in figures or in words then the rate quoted by the contractor in words shall be taken as correct. Where the rates quoted by the contractor in figures and in words tally but the amount is not worked out correctly, the rates quoted by the contractor will unless otherwise proved be taken as correct and not the amount. In event no rate has been quoted for any item(s), leaving space both in figure(s), word(s), and amount blank, it will be presumed that the contractor has included the cost of this/these item(s) in other items and rate for such item(s) will be considered as zero and work will be required to be executed accordingly.

In case the same item appears more than once in the schedule of work under the same sub head or among the different sub heads of works, the lowest rate quoted for that item shall be taken for other items also and tender will be evaluated accordingly.

13. The contractor whose tender is accepted shall be required to furnish by way of Initial security a sum which shall be equal to 2% (two percent) of the accepted value of the tender including the Earnest Money Deposit, within 14 (fourteen) days of the date of issue of the letter of acceptance of his tender, Demand Draft payable to the APG Bank or by way of Bank Guarantee from any other Scheduled Bank in the prescribed format for the duration of the contract period and defect liability period. A further sum of 8% (eight percent) of the Gross value of each interim/final bill shall be deducted as retention money.



**In case the successful tenderer fails to remit the Initial security deposit within the above stipulated time, the Earnest money deposit shall be forfeited as per the discretion of the Bank.**

14. In the case of any tender where unit rate of any item/items appears unrealistic, such tender will be considered as unbalanced and in case the tenderer is unable to provide satisfactory explanation such a tender is liable to be disqualified and rejected and / or the tenderer is liable for **additional security deposit** as demanded by the Employer in the form of Demand Draft or Bank guarantee from scheduled commercial Bank valid for contract period / smaller period ( as decided by the Bank ) in the format prescribed by the Bank.
15. On acceptance of the tender, the name of the accredited representative(s) of the contractor who would be responsible for taking instructions from the Employer
16. The rates quoted shall be all Including the rates for the item of work described, including materials, labor, tools and plant, lead, lift carriage and transport supervision, and exclusive of Royalties, duties, levies, cess, entry tax, octroi, profession tax, GST, purchase tax, turnover tax, or any other tax on material in respect of this contract, overheads and profits, mobilizing, demolishing and other charges whatsoever including any special difficulties any restrictions for transport etc., complete for proper execution of the work as per drawings and specifications and no claim whatsoever for any extra payment shall be maintainable.

GST or any other Tax, any royalties, duties, levies, cess, Entry Tax, octroi, Profession Tax, Turnover Tax or any other Tax on material in respect of this contract shall be payable by the tenderer and the Bank will not entertain any claim whatsoever in respect of the same and nothing extra shall be paid / reimbursed for the same subsequently. The rates quoted shall include all the above. GST on works contract on finished works wherever applicable shall be paid by Bank as per extant rules. All charges payable to local bodies for any service connections for construction purposes, land tax, etc., shall also be paid by the contractor and nothing extra shall be paid/reimbursed for the same. **(Note: Item Rate + Profit) + GST Extra Quote Separately.)**

17. The tender for the work shall not be witnessed by a contractor or contractors who himself/themselves has/have tendered or who may and has/have tendered for the same work. Failure to observe this condition would render tenders of the contractors tendering, as well as witnessing the tender, liable to summary rejection.
18. Errors and omissions due to clerical, typographical or printing etc., if any, will have to be got clarified and corrected before quoting the rates. The interpretation given by the appropriate tender accepting authority of the Bank shall be final and binding.
19. Procurement of all materials, other than specifically stipulated to be issued by the Bank, if any, shall be at the cost and the responsibility of the contractor.
20. Provisions for Micro & Small Enterprises (MSEs):- As per Government of India's Public Procurement Policy act 2012, certain benefits will be given for MSE Units. The details are as under:
  - a) MSEs are exempted from paying Tender/RFP fee/cost, EMDs. For getting the benefits in case of MSE firms, shall submit relevant documents such as valid MSE registration Certificates and exemption certificate from relevant authorities.
21. Tenderer shall fill in all the blanks and put their signature and seal on each page of the tender documents. The successful Tenderer will have to enter into an agreement with each component of the Tender document with the Bank.

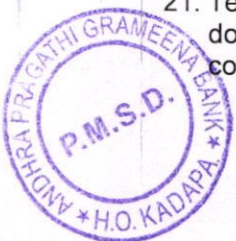

## Special Conditions of the Contract

1. The scope of proposed works shall be as per specification described in the Schedule of Quantities.
2. **The building is used as Branch Building. It will be necessary to undertake the works in Single phase only.** The tenderers are required to keep this fact while quoting their rates. Duly considering this time constraints, the time for completion as indicted in notice inviting tenders is provided for.
3. The project involves execution of other Ancillary Works like Watchmen Shed, Temporary Water/Electrical Connection, in the proposed area. Hence the responsibility of proper co-ordination with other agencies who are assigned with above mentioned works, rests with the successful tenderer of this subject work / contract.
3. **Quoted Rates:**
  - (i) Contractor should note that, **the tender is strictly on item rate basis** and tenderers attention is drawn to the fact that rates for each and every item should be correct, workable and self-supporting. The quantities in the Schedule of Quantities approximately indicate the total extent of work but few items may vary beyond 25% quantity and few items may not be even operated.
  - (ii) The quoted rates shall be exclusive of all type of taxes (income tax, work contract tax, GST), octroi, excise duty, service charges, VAT and inclusive of loading, unloading, transportation, lead & lift charges and all charges incidental to complete the assigned works in all respects as per tender specifications and terms & conditions.
  - (iii) If called upon by the Bank, detailed analysis of any or of all the items shall be submitted by the Contractor. In case there are variations in the rates for items of same/ similar specifications, in such cases, the lowest rate quoted shall be considered unless Bank finds that there is justification for such inconsistent rates and this shall be the basis for any assessing any other non-tendered items also.
4. **Works and site to be kept and delivered up clean:** All dirt, waste and other rubbish as it accumulates from time to time during the progress of the work and at completion, including that of sub-contractors and special tradesmen to be cleared and carted away and all materials rejected by the Bank's representative to be removed and disposed of to approved dumping ground / area. Internal cleaning shall be done on daily basis & clearing of the debris shall be as & when the accumulated quantity comes to one tractor load. Contractor's quoted rates shall be inclusive of the cost of this cleaning / clearing.
5. **Supply of electricity, water, use of lifting Pumps, Material storage space etc.:** The successful tenderer will be allowed to make use of the available facilities of electrical power, water supply, for carrying out the tender works on charge basis as per actual at site. If not available, facility contractor has to make arrangement with his own cost within the work place, the contractor may make their own arrangement for safe keeping / storage of materials. Bank shall not provide any separate storage place for keeping the materials or for the site office and contractor shall be fully responsible for the safety of the materials and their labors.





## GENERAL CONDITIONS OF THE CONTRACT.

**1. Interpretation:** In construing these conditions, the specifications, the schedule of quantities, tender and Agreement, the following words shall have the meaning herein assigned to them except where the subject or context otherwise requires.

**Employer or Bank:** The term "Employer" or "Bank" shall denote APG BANK with their Head Office at KADAPA represented by **THE GENERAL MANAGER, HEAD OFFICE, located at KADAPA** and any of its employees or representative authorized on their behalf.

**Consultant Engineer:** The term "Consultant Engineer" shall mean the Consultant Engineer appointed by Bank Sri Y K Ravi Teja Reddy, for the subject works or in the event of his/their ceasing to be the Consultant Engineer for the purpose of this contract such other person/s the Employer shall nominate for the purpose.

- i) **Full Time Site Engineer:** The term "Engineer" shall mean authorized Engineer appointed by Contractor for day-to-day supervision of works at site as per tender terms.
- ii) **Contractors:** The term "Contractor"," Bidder" or "Tenderer" shall mean \_\_\_\_\_(Name and address of Contractor) and his/their heirs, legal representatives, assigns and successors.
- iii) **Site:** The "site" shall mean the office area located at **V N Palli Panchayath Kadapa District, Andhra Pradesh**, Where the proposed works are to be carried out as per tender Schedule of Quantities & working drawings allotted by the Employer for the contractor's use.
- iv) **Drawings:** "Drawings" means the drawings referred to in the Specification and any modification of such drawings approved in writing by the Consultant Engineer and such other drawings as may from time to time be furnished or approved in writing by the Consultant Engineer. The work is to be carried out in accordance with drawings, specifications, the schedule of quantities and any further drawings, which may be given by the Consultant Engineer during the execution of the work.

All drawings relating to work given to the contractor together with copy of schedule of quantities are to be kept at site and the Consultant Engineer shall be given access to such drawings or schedule of quantities whenever necessary.

In case any detailed Working/Fabrication/Shop Drawings are necessary, contractor shall prepare such detailed drawings and/or dimensioned sketches thereof and have it confirmed by the Consultant Engineer prior to taking up such work.

The contractor shall ask in writing for all clarifications on matters occurring anywhere in drawings, specifications and schedule of quantities or to additional instructions at least 10 days ahead from the time when it is required for implementations so that the Employer may be able to give decision thereon.

- v) "The Works" shall mean the work or works to be executed or done under bill of quantities of this contract and shall include materials, apparatus, equipment, plant, fittings and other things for incorporation in the works. Wherever the word "Construction" is referred the same may be understood as undertaking renovation of the interior, civil works as per Bill of quantities.
- vi) "Contract " means the contract effected by the contractor's Tender and the Employer's acceptance thereof comprising (in addition to the Tender and Acceptance) the priced bill of Quantities and Schedules, Schedules of particulars (if any), Specifications and Drawings, these General Conditions of Contract, Special Conditions contained in or attached to any of the forgoing documents, any alterations agreed in writing between the parties before the



formal acceptance of the Tender, all these documents taken together, shall be deemed to form one contract and shall be complementary to one another.

- vii) "Specification" means the specification annexed to or issued with these conditions and includes Indian or British or other approved standard specifications where required by the specification and where such a specification is not available, the specification approved by the Consultant Engineer.
- viii) "Approved" means approved in writing including subsequent written confirmation of previous verbal approval and "approval" means approval in writing including as aforesaid.
- ix) "Market rate" means the rate as prevailing in the market and recommended by the Consultant Engineer and as approved by the Employer on the basis of cost of materials, labor, plant etc inclusive of any tax, duty, octroi etc. at the time of execution of work.
- x) "The Schedule of Quantities" or "Priced Schedule of Quantities" shall mean the schedule (or bill) of quantities as specified and forming part of this contract.
- xi) "Act of Insolvency" shall mean any act such as defined by the Presidency Towns Insolvency Act or in Provincial Insolvency Act or any amending statutes.

2. **SCOPE OF WORKS:** The work consists of carrying out civil works at **V N Palli Panchayat Kadapa District Andhra Pradesh** in accordance with the "drawings" and "Schedule of Quantities". All work, during its progress and upon completion, shall conform to the lines, elevations and grades as shown on the drawings furnished by the Employer/Consultant Engineer. Should any detail essential for efficient completion of the work be omitted from the drawings and specifications, it shall be the responsibility of the contractor to inform the Employer/Consultant Engineer and to furnish and install such detail with Employer's/Consultant Engineer' concurrence, so that upon completion of the proposed work the same will be acceptable and ready for use.

Employer/Consultant Engineer may in their absolute discretion issue further drawings and/or written instruction, details, directions & explanations, which are, hereafter collectively referred to as "The Employer's instructions" in regard to:

- a) The variation or modification of the design quality or quantity of works or the addition or omission or substitution of any work.
- b) Any discrepancy in the drawings or between the schedule of quantities and/or drawings and/or specification.
- c) The removal from the site of any defective material brought thereon by the contractor and the substitution of any other material thereof.
- d) The demolition removal and/or re-execution of any work executed by the contractor/s.
- e) The dismissal from the work of any persons employed there upon.
- f) The opening up for inspection of any work covered up.
- g) The rectification and making good of any defects under clauses hereinafter mentioned and those arising during the maintenance period (retention period).

The Contractor shall forthwith comply with and duly execute any work comprised in such Employer's/Consultant Engineer' instructions, provided always that verbal instructions, directions and explanations given to the contractors or his representative upon the works by the Employer/Consultant Engineer shall if involves a variation, be confirmed in writing to the contractor/s within seven days. No works, for which rates are not specifically mentioned in the priced schedule of quantities, shall be taken up without written permission of the Employer/Consultant Engineer. Rates of items not mentioned in the priced schedule of quantities shall be fixed by the employer in consultation with the Consultant Engineer as provided in Clause "variation".



Regarding all factory made products for which ISI marked products are available, only products bearing ISI marking shall be used in the work.

**3. Tenderer shall visit the site:** Intending tenderer shall visit the site and make them thoroughly acquainted with the local site condition, nature and requirements of the works, facilities of transport condition, effective labor and materials, access and storage for materials and removal of rubbish. The tenderer shall provide in their tender for cost of carriage, freight and other charges as also for any special difficulties, including police restriction for transport etc., for proper execution of work as indicated in the drawings. The successful tenderer will not be entitled to any claim of compensation for difficulties faced or losses incurred on account of any site condition which existed before the commencement of the work or which in the opinion of the Employer/Consultant Engineer might be deemed to have reasonably been inferred to be so existing before commencement of work.

**4. Tenders:** The entire set of tender paper issued to the tenderer should be submitted fully priced and also signed at appropriate places as detailed in the Instructions to Tenderers. No modifications, writings or corrections can be made in the tender papers by the tenderer, but may at his option offer his comments or modifications in a separate sheet of paper attached to the original tender papers. The Employer reserves the right to reject the lowest or any tender and also to discharge any or all of the tenders for each section or to split up and distribute any item of work to any specialist firm or firms, without assigning any reason.

The tenderers should note that the tender is strictly on the item rate basis and their attention is drawn to the fact that the rates for each and every item should be correct, workable and self-supporting. If called upon by the Employer/Consultant Engineer, detailed analysis of any or all the rates shall be submitted. The Employer/Consultant Engineer shall not be bound to recognize the contractor's analysis. The works will be paid for as "measured work" on the basis of actual work done on item rate basis and not as "lump sum" contract.

All items of work described in the schedule of quantities are to be deemed and paid as complete works in all respects and details including preparatory and finishing works involved, directly, related to and reasonably detectable from the drawings, specifications and schedule of quantities and no further extra charges will be allowed in this connection. In the case of lump-sum charges in the tender in respect of any item of works, the payment of such items of work will be made for the actual work done on the basis of lump-sum rates as will be assessed to be payable by the Employer/Consultant Engineer.

The tenderer shall note that his tender shall remain open for consideration for a period of 120 Days from the date of opening of the tender.

**5. Agreement:** The successful contractor will be required to sign a Contract Agreement as per enclosed Proforma shall pay for all stamps and legal expenses, incidental thereto. The contractor shall submit Indemnity Bond, Guarantee Certificates for specialized works in stamp papers as per Bank's approved Proforma.

**6. Permits and Licences:** Permits and Licenses for release of materials, which are under Government control, shall be arranged by the contractor. The Employer may render necessary assistance, sign any forms or applications that may be necessary but shall not be responsible for actual procurement or for any delay in procurement. It may be clearly understood that no compensation or additional charges can be claimed by the contractor for non-receipt of any controlled materials in due time on this account or according to his own requirements. The contractor shall at his own cost arrange for storage for taking delivery and storing of the quantity of controlled materials released by the authorities or supplied by the Employer. The costs of storing, transporting, etc., of all materials including those under Government control are to be included by the tenderer in his quoted rates. The Employer/Consultant Engineer shall be indemnified against all legal actions for the theft or misuse of controlled materials in the custody of the contractor.



**7. Government and Local rules:** The contractor shall confirm to the provisions of all local Bye-laws and Acts relating to the work and to the Regulations etc., of the Government and Local Authorities and of any company with whose system the structure is proposed to be connected. The contractor shall give all notices required by said Act, Rules, Regulations and Bye-laws etc., and pay all fees payable to such authority/authorities for execution of the work involved. The cost, if any, shall be deemed to have been included in his quoted rates, taking into account all liabilities for licenses, fees for footpath encroachment and restorations etc., and shall indemnify the Employer against such liabilities and shall defend all actions arising from such claims or liabilities.

**8. Taxes and Duties:** The tenderers must exclude in their tender prices quoted for all duties royalties, cess and sales tax or any other taxes or local charges if applicable. No claim on this account will in any case be entertained. Only GST will be paid extra as applicable.

**9. Provisional Sums (P S):** All provisional sums described in the schedule of quantities as P S shall be exclusively allotted to the purchase of materials and not for any handling and fixing to be done by the contractor. Such costs of handling and fixing with profit (including transport charges if required) shall be separately included in the contract price as described in the schedule of quantities. The disposal of the amounts covered under this head will be absolutely at the discretion of the Employer. Contractor is to make payment for these materials to the suppliers on certificate or order issued by the Employer/ Consultant Engineer and realizes them through his bills from the Employer.

**10. Final Acceptance/ Completion Certificate:** The Work shall be considered as complete when Consultant Engineer has certified in writing subject to the following.

- a. Only after the demonstration of the integrated operation, trial run and approval by the Local Authority, satisfactory performance tests and necessary documentation and information furnished as per the Contract, shall the Consultant Engineer issue the Completion Certificate to the contractor certifying completion of Work as per the terms of this Contract ("**Completion Certificate**").
- b. Minor defects, which do not affect the safe operation of the equipment at the rated capacity, if accepted by the Project Manager, shall not be considered as reason for the installation being not ready for handing over. These defects will be notified to the Contractor and will be rectified by the Contractor in a mutually agreed schedule.
- c. All equipment, tools and tackles and any special instruments required, for conducting pre-commissioning and performance tests shall be provided by the Contractor at their cost.
- d. If by reason of any default on the part of the Contractor, a Completion Certificate has not been issued in respect of every portion of the work within one week after the Completion Date or extended time as the case may be, the Bank shall be at liberty to use the work or any portion thereof, in respect of which a Completion Certificate has not been issued, provided that Work or the portion so used as aforesaid shall be reasonably capable of being used and that the Contractor shall be afforded the earliest opportunity of taking such steps as may be necessary to permit the issue of completion certificate.
- e. The Bank shall be at liberty from time to time or at any time before the completion of the work to take possession of and use any part of the site or uncompleted work and in such case the Contractor shall completely finish the said incomplete parts or a part of the work as and when the Consultant Engineer shall direct whether before or after the respective prescribed time or extended time (if any) for the completion of the work and if required by the Consultant Engineer while the Bank is in possession of the said part or parts of the Site or work.

The Defect Liability Period shall commence from the date of issuance of Completion certificate. Should the Bank decide to occupy any portion of the building or use any part of any equipment, before the contract is completed, same shall not constitute an acceptance of any part of the Work unless so stated in writing by the Bank.

**11. Other persons engaged by the Employer:** The Employer reserves the right to execute any part of the work included in this contract or any work, which is not included in this contract by other Agency or persons, and contractor shall allow all reasonable facilities and use of his scaffolding for



the execution of such work. The main contractor shall extend all cooperation in this regard.

**12. Earnest Money, Security Deposit & Retention Money:** The tenderer will have to deposit the amount specified in the Tender Notice in the form of Bank Draft drawn in favor of APGB Bank, HEAD OFFICE, KADAPA at the time of submission of tender as Earnest Money. The employer is not liable to pay any interest on the Earnest Money. The Earnest money of the unsuccessful tenderers will be refunded without any interest soon after the decision to award the work is taken or after the expiry of the validity period of the tender.

The successful tenderer to whom the contract is awarded will have to deposit as initial security deposit (including the Earnest Money) a further sum to make up 2% of the value of the accepted tender. The initial Security Deposit will have to be made within 14 days from the date of acceptance of tender, failing which the Employer at his discretion, without prejudice to any other rights/remedies available under the terms of this Contract may revoke the letter of acceptance and forfeit the Earnest money deposit furnished along with the tender. The initial Security Deposit will not yield any interest & shall be held at Bank's end for the duration of the contract period. It shall be refunded to the contractor without any interest within fourteen days after the issue of certificates of virtual completion, after deducting any sum due from the contractor on any account under this contract.

Apart from the initial security deposit made as above, retention money shall be deducted from progressive bills @ **8% of the gross value of each interim/final bill.**

The retention amount will be refunded to the contractor, after deducting any sum due from the contractor on any account under this contract, 14 (fourteen) days after the end of defects liability period provided he has satisfactorily carried out all the work and attended to all defects in accordance with the conditions of the contract.

No interest is allowed on retention money. A part of the Security Deposit if and as decided by the bank can also be furnished in the form of a bank guarantee.

**13. Contractor to provide everything necessary:** The contractor shall provide everything necessary for the proper execution of the work according to the intent and meaning of the drawings, schedule of quantities and specifications taken together whether the same may or may not be particularly shown or described therein provided that the same can reasonably be inferred there from and if the contractor finds any discrepancies therein he shall immediately and in writing, refer the same to the Employer/ Consultant Engineer whose decision shall be final and binding. The contractor shall provide himself everything necessary for carrying out of the works at his own cost. The Employer shall on no account be responsible for the expenses incurred by the contractor for obtaining any resources from elsewhere.

The rates quoted against individual items will be inclusive of everything necessary to complete the said items of work within the contemplation of the contract, and beyond the unit price no extra payment will be allowed for incidental or contingent work, labor and/or materials inclusive of all taxes and duties whatsoever except for specific items, if any, stipulated in the tender documents.

The contractor shall supply, fix and maintain at his own cost, for the execution of any work, all tools, tackle, machineries and equipment and all the necessary centering, scaffolding, staging, planking, timbering, strutting, shoring, pumping, fencing, boarding, watching and lighting by night as well as by day required not only for the proper execution and protection of the said work but also for the protection of the public and safety of any adjacent roads, streets, walls, houses, building, all other erections, matters and things and the contractor shall take down and remove any or all such centering, scaffolding, planking, timbering, strutting, shorting etc., as occasion shall be required or when ordered so to do, and shall fully reinstate and make good all matters and things disturbed during the execution of works to the satisfaction of the Employer/Consultant Engineer.

The contractor shall also provide such temporary partitions / works on the site as may be necessary for the proper performance of the contract and for his own convenience but not otherwise. Upon



completion, such temporary materials shall be cleared unless the Employer shall otherwise direct.

The contractor shall at all times give access to workers employed by the Employer or any men employed on the buildings and to provide such parties with proper sufficient and if required, special scaffolding, hoists and ladders and provide them with water and lighting and leave or make any holes, grooves etc., in any work, where directed by the employer as may be required to enable such workmen to lay or fix pipes, electrical wiring, special fittings etc. The quoted rates of the tenderers shall accordingly include all these above-mentioned contingent works.

**14. Time of completion, Extension of time:** The time allowed for carrying out the work as per the terms of this contract shall be strictly observed by the Contractor and shall be deemed to be the essence of the Contract and shall be reckoned from the date of award of the Contract. The Work shall proceed with due diligence until final completion of the work. The date of commencement of the work shall be within 7 days from the date of issue of letter of intent / workorder and completion of project within the allotted time as per notice inviting tenders. In case the Contractor fails to meet the above-stipulated Completion date, Contractor shall be liable to pay the bank Liquidated Damages as specified in this Contract under **clause 18**. In addition to the overall time period, the Contractor shall provide access to sub-contractors to undertake their portion of works, employed directly by the Bank.

Causes of delay for which claims for extension of time may be considered;  
The Contractor shall be entitled to claim for extension of time, subject to the conditions herein, should he be delayed or impeded in the execution of the work by reason of the following:

- a. Force Majeure;
- b. Any change orders directed by the Bank, which in the opinion of the Project minimize the effect of such delays. Bank entails the requirement of additional time for completion of the Work.

In respect of items (a) and (b) above, the Contractor shall submit in writing to the Bank his intention to claim for an extension of time within seven (7) working days of any of the above mentioned reasons or events causing a delay. Any claim of extension of time in respect of item (b) shall be notified by the Contractor before such change order is actually issued. The Contractor shall thereafter detail and submit his claim for the extension of time within fourteen (14) working days of such delay having occurred. If the Contractor does not comply with both these conditions for each and every delay caused by any of the above mentioned reasons or events, then he shall not be entitled to any extension of time.

The Bank shall study and verify the particulars of the claim for extension of time submitted by the Contractor and shall then reject or amend or accept the claim. Bank will extend the time by notifying the Contractor in writing for completion of the Work by such period as it shall think adequate with the prior approval of the appropriate authority of the bank and the time for completion of the Work so extended shall for all purposes of the Contract be deemed the time specified for completion of the Work. The decision of the Bank in this regard shall be final and binding on the Contractor. No extension of time shall be granted separately for any concurrent or parallel activities, and only a delay, caused by any of the above mentioned reasons or events, in a critical activity which has a direct effect on the overall completion of the Work, shall form a basis for granting extension of time.

Should any deletions or changes in the scope of the Work reduce the time required to complete the work under the Contract, then the time savings accruing from such deletions may be considered by the Bank in off-setting the durations awarded for an extension of time.

The Contractor shall not be entitled to any compensation for any loss suffered by him on account of delays in commencing or in executing or in completing the Work, whatever might be the cause of the delay if such delay is on account of the Contractor.

**Protective Measures:** The contractor from the time of being placed in possession of the site must make suitable arrangements for protecting the work, the site and surrounding property and no



extra will be paid by Bank for such services. Contractor shall indemnify the Employer against any possible damage to the building, vehicles parked in the premises, roads or members of the public in course of execution of the work. The contractor shall provide necessary temporary enclosures etc., for the protection of the work and materials and for altering and adopting the same as may be required and removing on completion of the works and making good all works disturbed.

**15. Storage of materials:** The contractor shall provide and maintain proper sheds for the proper storage and adequate protection of the materials etc., and other work that may be executed on the site including the tools and materials of sub-contractors and remove the same on completion. Sheds for storage of cement should have pucca floor raised above the ground.

**Tools:** Theodolite levels, prismatic compass, chain, steel and metallic tapes and all other surveying instruments found necessary for the works shall be provided by the contractor for the due performance of this contract as instructed by the Site Engineer.

All measuring tapes shall be of steel and suitable scaffolding and ladders that may be required for safely taking measurement and shall be supplied by the contractor.

The maystries and the supervisor on the works shall carry with them necessary instruments like a steel tape, a measuring tape of 30 meters, a spirit level, a plumb bob and a square and shall check the work to ensure that the work is being done according to the drawing and specifications. The Site Engineer will use any or all measuring instruments or tools belonging to the contractors as he chooses for checking the works executed or being executed on the contract.

The contractor should cover in his rates for making provisions for all reasonable facilities for the use of his scaffolding, tools & plant etc. by subcontractors for their work.

**16. Notice and Patents of appropriate authority and owners :** The contractor shall conform to the provisions of any Acts of the Legislature relating to the work, and to the Regulations and Bye-laws of any authorities, and /or any water, lighting and other companies, and/or authorities with whose systems the structures were proposed to have connection and shall before making any variations from the drawings or specification that may be associated to so conform, give the Employer/Consultant Engineer written notices specifying the variations proposed to be made and the reasons for making them and apply for instruction thereon. The Employer/Consultant Engineer on receipt of such intimation shall give a decision within a reasonable time.

The contractor/s shall arrange to give all notices required for by the said Acts, Regulations or Bye-laws to be given to any authority, and to pay to such authority or to any public officer all fees that may be properly chargeable in respect of the work and lodge the receipts with the Employer.

The contractor shall indemnify the Employer against all claims in respect of patent rights, royalties, damages to buildings, roads or members of public in course of execution of work and shall defend all actions arising from such claims and shall keep the Employer saved harmless and indemnified in all respects from such actions, costs and expenses.

**17. Clearing site and Setting out works:** The site shown on the plan shall be cleared of all obstructions, loose stone, and materials rubbish of all kinds. All holed or hollows whether originally existing or produced by removal of loose stone or materials shall be carefully filled up with earth well rammed and leveled off as directed at his own cost.

The contractor shall set out the works and shall be responsible for the true and perfect setting out of the work and for the correctness of the positions, levels, dimensions and alignment of all

parts thereof. If at any time, any error shall appear during the progress of any part of the work, the contractor shall at his own expenses rectify such error, if called upon to the satisfaction of the Employer. The contractor shall further set out the works to the alternative positions at the site until one is finally approved and the rates quoted in his tender should include for this and no extra on this account will be entertained.

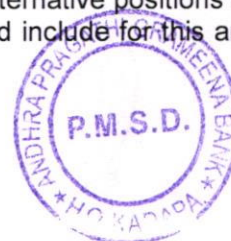

**18. Liquidated damages :** If the Contractor fails to complete the works within the time for completion stated in the Appendix/elsewhere or within any extended time under **Clause 14** hereof, **the Contractor shall pay the Employer the sum at the rate of 0.5%(Half percent) of the Contract Value per week of delay subject to a limit of 10%(ten percent) of the Contract Value as "Liquidated damages"** for the period during which the said works shall so remain incomplete or the Employer may deduct aforesaid sum towards such damages from any monies due to the Contractor.

**19. Contractor immediately to remove all offensive matters:** All soil, filth or other matters of any offensive nature taken out of any trench, sewer, drain, cesspool or other place shall not be deposited on the surface but shall be at once carted away by the contractor to the place provided by him. The contractor shall keep the foundations and works free from water and shall provide and maintain at his own expenses electrically or other power driven pumps and other plant to the satisfaction of the Employer for the purpose, until the building is handedover to the Employer. The contractor shall arrange for the disposal of the water so accumulated to the satisfaction of the Employer and local authority and no claims will be entertained afterwards if he does not include in his rates for the purpose.

**20. Access to inspection authorities:** Any authorized representative of the Employer shall at all reasonable times have free access to the works and/or to the workshop, factories or other places where materials are being prepared or constructed for the work and also to any place where the materials are lying or from where they are being obtained, and the contractor shall give every facility to the bank or their representatives necessary for inspection and examination and test of the materials and workmanship.

Contractor shall cooperate with the Bank's inspection authorities and external inspection agencies like Central Vigilance Commission (CVC) in inspecting the works executed / being executed and shall provide the required information as sought by such authorities.

**21. Materials, Workmanship, Samples, Testing of materials :** All the works specified and provided for in the specifications or which may be required to be done in order to perform and complete any part thereof shall be executed in the best and approved quality of the respective kinds in accordance with the particulars contained in and implied by the specifications and as represented by the drawings or according to such other additional particulars, and instructions as may from time to time be given by the Employer/Consultant Engineer during the execution of the work, and to his entire satisfaction.

Whenever required by the Employer /Consultant Engineer the contractor shall have to carry out tests on materials and workmanship in approved materials testing laboratories as prescribed by the Employer/Consultant Engineer to prove that the materials etc., under test conform to the relevant I.S. Standards or as specified in the specifications. The necessary charges for preparation of mould (in case of concrete cube) and test samples transporting, testing etc., shall have to be borne by the contractor but the actual cost of testing will be paid / reimbursed by Bank. However, when test certificates from the original manufacturer / supplier of the materials are called no payment for the testing etc. would be payable nor entertained.

All the materials (except where otherwise described) stores and equipment required for the full performance of the work under the contract must be provided through normal channels and must include charge for import duties, sales tax, octroi and other charges and must be the best of their kind available and the contractor/s must be entirely responsible for the proper and efficient carrying out of the work. The work must be done in the best workman like manner. Samples of all materials to be used must be submitted to the Employer/Consultant Engineer when so directed by the Engineer/ Consultant Engineer and written approval from Employer/Consultant Engineer must be obtained prior to placement of order.

During the inclement weather the contractor shall suspend concreting and plastering for such time as the Employer/Consultant Engineer may direct and shall protect from injury all work when in





course of execution. Any damage during constructions, to any part of the work, for any reasons, due to rain, storm, or neglect of contractor, shall be rectified by the contractor, in an approved manner at no extra cost.

Should the work be suspended by reason of rain, strike, lockouts or any other cause, the contractor shall take all precautions necessary for the protection of work and at his own expenses shall make good any damage arising from any of these causes.

The contractor shall cover up and protect from damage, from any cause, all end work and supply all temporary doors, protection to windows, and any other requisite protection for the execution of the work whether by himself or special tradesmen or subcontractor and any damage caused must be made good by the contractor at his own expenses.

**22. Removal of improper work :** The Employer shall during the progress of the work have power to order in writing from time to time the removal from the work within such reasonable time or times as may be specified in the order of any materials which in the opinion of the Employer/Consultant Engineer are not in accordance with specifications of instruction, the substitution or proper re-execution of any work executed with materials or workmanship not in accordance with the drawings and specifications or instructions. In case the contractor refuses to comply with the order the Employer shall have the power to employ and pay other agencies to carry out the work and all expenses consequent thereon or incidental thereto as certified by the Employer/ Consultant Engineer shall be borne by the contractor or may be deducted from any money due to or that may become due to the contractor. No certificate, which may be given by the Consultant Engineer, shall relieve the contractor from his liability in respect of unsound work or bad materials.

**23. Site Engineer:** The term 'Site Engineer' shall mean the person if any, appointed and paid by the Employer to superintend the work. The contractor shall afford the Site Engineer every facility and assistance for examining the works and materials and for checking and measuring work and materials. The Site Engineer shall have no power to revoke, alter, enlarge or relax any requirements of the contract or to sanction any day work, additions, alterations, deviations or omissions or any extra work whatever, except in so far as such authority may be specially conferred by a written order of the Employer.

The Site Engineer shall have power to give notice to the contractor or to his foreman, of non-approval of any work or materials and such work shall be suspended or the use of such materials shall be discontinued until the decision of the Employer is obtained. The work will from time to time be examined by the Consultant Engineer, Engineer from the Premises Department of the Employer. But such examination shall not in any way exonerate the contractor from the obligation to remedy any defects, which may be found to exist at any stage of the work or after the same is complete. Subject to the limitations of this clause the contractor shall take instructions only from the Consultant Engineer/Employer.

**24. Office accommodation for the Contractor:** The contractor shall not be provided with site office for accommodation of their Site Engineer/ personnel's / workers within the site. Facilities within the available work area can be used with due concurrence of the employer whose decision will be final.

**25. Contractor's Employees:** The contractor shall employ technically qualified and competent supervisors for the work who shall be available (by turn) throughout the working hours to receive and comply with instructions of the Employer/Consultant Engineer. The contractor shall engage at least one experienced Engineer with Diploma in relevant field as site-in charge for execution of the work. The contractor shall employ in connection with the work, persons having the appropriate skill or ability to perform their job efficiently. **No laborer below the age of Eighteen years and who is not an Indian National shall be employed on the work.** Any laborer supplied by the contractor to be engaged on the work on day-work basis either wholly or partly under the direct order or control of the Employer or his representative shall be deemed to be a person employed by the contractor. The contractor shall comply with the provisions of all labor legislation including the

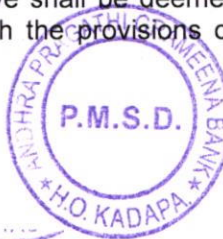

requirements of

- a) The Payment of Wages Act
- b) Employer's Liability Act
- c) Workmen's Compensation Act
- d) Contract Labor (Regulation & Abolition) Act, 1970 and Central Rules 1971
- e) Apprentices Act 1981
- f) Any other Act or enactment relating thereto and rules framed there under from time to time.
- g) Indian Electricity Act (IE Act) and follow the rules.

The contractor shall keep the Employer saved harmless and indemnified against claims if any of the workmen and all costs and expenses as may be incurred by the Employer in connection with any claim that may be made by any workmen.

The contractor shall comply at his own cost with the order of requirement of any Health Officer of the State or any local authority or of the Employer regarding the maintenance of proper environmental sanitation of the area where the contractor's laborers are accommodated, for the prevention of contagious diseases. Adequate precautions shall be taken by the contractor to prevent nuisance of any kind on the works or the place adjoining the same.

The contractor shall arrange to provide first aid treatment to the laborers engaged on the works. He shall within 24 hours of the occurrence of any accident at or about the site or in connection with execution of the works, report such accident to the Employer and also to the competent authority where such report is required by law.

**26. Dismissal of Workman:** The contractor shall on the request of the Employer immediately dismiss any person employed thereon by him, who may in the opinion of the Employer be unsuitable or incompetent or who may misconduct himself. Such discharges shall not be the basis of any claim for compensation or damages against the employer or any of their officer or employee.

**27. Assignment:** The whole of the works included in the contract shall be executed by the contractor and the contractor shall not directly or indirectly transfer, assign or sublet the contract or any a part, share or interest therein nor, shall take a new partner, without written consent of the Employer and no such consent shall relieve the contractor from the full and entire responsibility of the contract or from active superintendence of the work during their progress.

**28. Damage to persons and property insurance etc.:** The contractor shall be responsible for all injury to the work or workmen, persons, animals or things and for all damages to the structural and/or decorative part of property which may arise from the operations or neglect of himself or of any sub-contractor or of any of his or a sub-contractor's employees, whether such injury or damage arise from carelessness, accident or any other cause whatsoever in any way connected with the carrying out of this contract. The clause shall be held to include inter-alia, any damage to buildings whether immediately adjacent or otherwise, and any damage to roads, streets, foot paths or ways as well as damages caused to the buildings and the works forming the subject of this contract by rain, wind or other inclemency of the weather. The contractor shall indemnify the Employer and hold harmless in respect of all and any expenses arising from any such injury or damages to persons or property as aforesaid and also in respect of any claim made in respect of injury or damages under any acts of compensation or damage consequent upon such claim.

The contractor shall reinstate all damage of every sort mentioned in this clause, so as to deliver the whole of the contract works complete and perfect in every respect and so as to make good or otherwise satisfy all claims for damages to the property or third parties.

The contractor shall effect the insurance necessary and indemnify the Employer entirely from all responsibility in this respect. The insurance must be placed with a company approved by the Employer and must be effected jointly in the name of the contractor and the Employer and the policy lodged with the latter. The scope of insurance is to include damage or loss to the works itself till this



is made over in a complete state. Insurance is compulsory and must be effected from the very initial stage. The contractor shall also be responsible for anything, which may be excluded from damage to any property arising out of incidents, negligence or defective carrying out of this contract.

The Employer shall be at liberty and is hereby empowered to deduct the amount of any damages, compensations, costs, charges and expenses arising or accruing from or in respect of any such claim or damages from any sums due or to become due to the contractor.

**29. Insurance:** The Contractor shall be responsible for all injury or damage to persons, employees, laborers, animals or things and for all damage to property, which may arise from any factor/omission on the part of the Contractor or any Sub-Contractor or any of their employees. The liabilities under this Clause shall cover also, inter alia any damage to roads, streets, footpaths, and bridges as well as damage caused to the building and other structures and works forming the subject matter of this contract. The Contractor shall also be responsible for any damage caused to the buildings and other structure's and works forming the subject matter of this contract due to rain, wind, fire, flood or high tide or other inclemency of weather. The Contractor shall indemnify and keep indemnified the Employer and hold him harmless in respect of all and any loss and expenses arising from any such injury or damage to persons or property as aforesaid and also against any claim made in respect of injury or damage, whether under any statute or otherwise and also in respect of any award or compensation or damage consequent upon such claims.

The Contractor shall, at his own expense, effect and maintain till the Defects Liability Period is over, with an insurance company approved by the Employer.

**Contractors All Risks Policy** for Insurance for the full amount of the contract including earthquake risk in the joint names of the Employer and the Contractor (the name of the former being placed first in the policy.) with Employer as beneficiary against all risk as per the standard all risk policy for Contractors and deposit such policy or policies with the Employer with seven days of issuing the work order.

The Contractor shall reinstate all damage of every sort mentioned in this clause so as to do delivery of the whole of the works complete and perfect in every respect and so as to make good or otherwise satisfy all claims for damage to property or third parties.

The Contractor shall also indemnify and keep indemnified the Employer/Consultant Engineer against all claims which may be made against the Employer by any persons in respect of the works or in consequence thereof and shall at his own expense, effect and maintain until the virtual completion of the Contract, with an Insurance Company approved by the Employer a third party insurance policy in the joint names of the Employer and the Contractor (name of the former being placed first in the policy) against such risks and deposit such policy or policies before commencement of the works. The minimum limit of the coverage under the policy shall be Rs.5.0lakhs per person for any one accident or occurrence and Rs.20.0lakhs in respect of damage to property for any one accident or occurrence.

The Contractor shall also indemnify the Employer against all claims which may be made upon the Employer, whether under the Workmen's Compensation Act or any other statute in force, during the currency of this contract or at Common Law in respect of any employee of the Contractor or of sub-Contractor and shall be at his own expense effect and maintain until the virtual completion of the Contract, with an Insurance Company, approved by the Employer, a policy of Insurance against such risks and deposit such policy or policies with the Employer fromtime to time during the currency of this contract.

In default of the Contractor insuring as provided above, **the Employer may also insure and may deduct the premiums paid plus the administrative fees of 15% of the sum payable to insuring agencies departmental charges** from any money due or which may become due to the contractor.

The Contractor shall be responsible for any liability which may not be covered by the Insurance



Policies referred to above and also for all other damages to any person, animal or defective carrying out of this contract, whatever, maybe the reasons due to which the damage shall have been caused.

The Contractor shall be also indemnify and keep indemnified the Employer against all and any costs, charges expenses arising out of any claim or proceedings relating to the works and also in respect of any award of damage or compensation arising there from.

Without prejudice to the other rights of the Employer against Contractors in respect of such default, the Employer shall be entitled to deduct the sum paid to the Insurance Company with **15% extra as departmental charges** from any sums payable to the Contractor the amount of any damages, compensation costs, charges and other expenses paid by the Employer and which are payable by the Contractor under this clause.

The Contractor shall upon settlement by the Insurer of any claim made against the insurer pursuant to a policy taken under this clause, proceed with due diligence to rebuild or repair the works destroyed or damaged. In this event all the monies received from the Insurer in respect of such damage shall be paid to the Contractor and the Contractor shall not be entitled to any further payment in respect of the expenditure incurred for rebuilding or repairing of the materials or goods destroyed or damaged.

The Contractor, in case of re-building or reinstatement after damage shall be entitled to such extension of time for completion as the Consultant Engineer may deem fit, but shall, however, not be entitled to reimbursement by the Employer of any shortfall or deficiency in the amount paid by the insurer in settlement of any claim arising as set out herein.

Without prejudice to his liability under this clause, the Contractor shall also cause all sub-Contractors to effect for their respective portions of the works, similar policies of insurance in accordance with the provisions of this clause and shall produce or cause to produce to the Employer such policies. The Contractor shall not permit a sub-Contractor to commence work at the site unless the said insurance policies are submitted. In the event of failure of the sub- contractor to commence work at the site, the contractor shall be responsible for any claim or damage attributable to the said sub-Contractor.

**30. Accounts Receipts & Vouchers:** The contractor shall, upon the request of the Employer furnish them with all the invoices, accounts, receipts and other vouchers that they may require in connection with the works under this contract, if the contractor shall use materials less than what he is required under the contract, the value of the difference in the quantity of the materials he was required to use and that he actually used shall be deducted from his dues. The decision of the Employer shall be final and binding on the contractor as to the amount of materials the contractor is required to use for any work under this contract.

**31. Measurements:** Before taking any measurement of any work the Site Engineer or a subordinate deputed by him shall give reasonable notice to the contractor. If the contractor fails to attend at the measurements after such notice or fails to counter sign or to record the difference within a week from the date of measurement in the manner required by the Site Engineer then in any such event the measurements taken by the Site Engineer or by the subordinate deputed by him as the case may be is final and binding on the contractor and the contractor shall have no right to dispute the same.

**32. Payments: Initial Mobilization Advance:** In case the successful contractor requests for mobilization advance, Bank may not consider paying such advance.

**Running Bill payments:** All bills shall be prepared by the contractor in the form prescribed by the Consultant Engineer. Normally interim bills shall be considered subject to minimum value as stated in the Appendix. The bills in proper forms must be duly accompanied by detailed measurements & test certificate in support of the quantities of work done and must show deductions for all previous payments, retention money, etc



The Consultant Engineer shall issue a certificate after due scrutiny of the contractor's bill stating the amount due to the contractor from the Employer and the contractor shall be entitled to payment thereof, within the period of honoring certificate stated in the Appendix.

The amount stated in an interim certificate shall be the value of work properly executed and material advance up to 75% of invoiced value of materials brought to site for permanent incorporation into the work after preparation of the previous bill less the amount to be retained by the Employer as retention money vide clause 12 of these conditions. Advance paid for materials already incorporated in the work shall be recovered.

The material advance shall be admissible only on materials, which in the opinion of the Consultant Engineer, are imperishable in nature, are genuinely required for use in the work in the near future, are of the required quality and are adequately protected against damage, theft, loss etc. If the Employer has supplied any materials or goods to the contractor, the cost of any such materials or goods will be progressively deducted from the amount due to contractor in accordance with the quantities consumed in the work.

All the interim payments shall be regarded as payments by way of advance against the final payment only and not as payments for work actually done and completed, and shall not preclude the requiring of bad, unsound, and imperfect or unskilled work to be removed and taken away and reconstructed, or re-erected or be considered as an admission of the due performance of the contract, or any part thereof in any respect or the accruing of any claim, nor shall it conclude, determine or affect in anyway the power of the Employer under these conditions or any of them as to the final settlement and adjustment of the accounts or otherwise or in any other way vary or affect the contract.

**33. Final payment:** The final bill shall be submitted by the contractor to the Consultant Engineer at the earliest but not later than 40 days from the date of completion of the works as certified by the Consultant Engineer and payment shall be made within the specified period as in Appendix for such of those items and quantities that in the opinion of the Employer, are undisputed.

The Final Bill shall be accompanied by a "Certificate of Completion" from the Consultant Engineer. Payments of final bill shall be made after deduction of Retention Money as specified in clause 12 of these conditions which sum shall be refunded as stipulated in Clause 12. The acceptance of payment of the final bill by the contractor would indicate that he will have no further claim in respect of the work executed.

**34. Variation / Deviation:** The quantities shown in the schedule of quantities are only approximate and are intended to cover the entire new structure indicated in the drawings but the Employer reserves the right to execute only a part or the whole or any excess thereof without assigning any reason therefore.

The Employer shall have powers to order additional /non-tendered items to modify the tendered items, to vary the quantities of tendered items and not to execute certain items. All such orders shall be in writing. The rate or price of all such additional items/non-tendered/modified items will be worked out on the basis of rates quoted for similar items in the contract wherever existing or on engineering rate analysis based on prevalent fair price of labor, material and other components as required. The tender rates shall hold good for any increase or decrease in the tendered quantities up to an excess of 75%. For quantities beyond 75% excess, the rate may be reviewed based on prevalent fair price of labor, materials and other components as per the rate analysis format given in Appendix-2 The contractor shall submit detailed analysis of rates and supporting documents to the Consultant Engineer within 14 days of being directed to execute such items/quantities and the Consultant Engineer shall assess the analysis and approve reasonable and justified rate. No such additional or modified items or variation in quantities (except variation in quantities as per approved drawings) shall be executed by the Contractor without prior written approval of the Employer/ Consultant Engineer.



- 35. Substitution:** Should the contractor desire to substitute any materials and workmanship, he/they must obtain the approval of the Employer/Consultant Engineer in writing for any such substitution well in advance. For materials designated in the Schedule of Quantities and specification indefinitely by such term as "Equal", "Equivalent" or "Other approved" etc.

Specific approval of the Employer/Consultant Engineer shall be obtained in writing. All such substitution may be subject to suitable price adjustment if considered necessary by the Consultant Engineer/Employer.

- 36. Completion of work:** On completion of the work the contractor shall clean all windows, doors, fittings, fixtures etc. of all paint/polish/distemper splashes/dirt/dust etc. if necessary all hardware, clean inside and outside, all floor, stair-cases, and every part of the building and the surroundings. The whole of the work will be thoroughly inspected by the contractor and deficiencies and defects set right. On completion of such inspection the contractor shall inform the Employer in writing that he has completed the work and it is ready for inspection.

On receipt of such written intimation from the contractor, the Employer/Consultant Engineer shall arrange to inspect the work and certify completion if the work has been completed satisfactorily. If not, the Employer/Consultant Engineer shall inform the Contractor the deficiencies/defects in the work and the contractor shall attend to them properly and again intimate the Employer/Consultant Engineer for further inspection. The work shall not be considered as complete until the Employer/Consultant Engineer have certified in writing that it has been completed satisfactorily without any apparent defects and the Defects Liability Period shall commence from the date of such certificate.

No such certificates shall be issued until the contractor clears away and removes from the site all constructional plant, surplus materials, rubbish temporary works of every kind and leaves the whole of the site and the works clean and in a workman like condition to the satisfaction of the Employer/Consultant Engineer.

- 37. Defects after completion:** The contractor shall make good at his own cost and to the satisfaction of the Employer all defects, shrinkage, settlements or other faults, which may appear within 24 months after completion of the work. In default the Employer may employ and pay other persons to amend and make good such damages, losses and expenses consequent thereon or incidental thereto shall be made good and borne by the contractor and such damages, loss and expenses shall be recoverable from him by the Employer or may be deducted by the employer, in lieu of such amending and making good by the contractor a sum equivalent to the cost of amending such work and in the event of the amount retained being insufficient, recover that balance from the contractor from the amount retained under clause No.12 together with any expenses the Employer may have incurred in connection therewith.

- 38. Concealed Work:** The contractor shall give due notice to the Employer/Consultant Engineer whenever any work is to be buried in the earth, concrete or in the bodies of walls or otherwise becoming inaccessible later on, in order that the work may be inspected and correct dimensions taken before such burial, in default whereof the same shall, at the opinion of the Employer/Consultant Engineer be either opened up for measurement at the contractor's expense or no payment may be made for such materials. Should any dispute or differences arise after the execution of any work as to measurements etc., or other matters which cannot be conveniently tested or checked, the notes of the Employer/Consultant Engineer shall be accepted as correct and binding on the contractor.

- 39. Idle labour:** Whatever the reasons may be, no claim for idle labor, additional establishment cost of hire and labor charges of tools and plants would be entertained under any circumstances.

- 40. Suspension :** If the contractor except on account of any legal restraint upon the Employer preventing the continuance of the work or in the opinion of the Employer shall neglect or fail to



proceed with due diligence in the performance of his part of the contract or if he shall more than once make default, the Employer shall have the power to give notice in writing to the contractor requiring the work be proceeded within a reasonable manner and with reasonable dispatch, such notice purport to be a notice under this clause.

After such notice shall have been given the contractor shall not be at liberty to remove from the site of the works or from any ground contiguous thereto any plant or materials to subsist from the date of such notice being given until the notice shall have been complied with. If the contractor shall fail for 7 (seven) days after such notice has been given to proceed with the works as therein prescribe, the Employer may proceed as provided in clause 41 (Termination of Contract by Employer).

**41. Termination of contract by Employer :** If the contractor being a company go into liquidation whether voluntary or compulsory or being a firm shall be dissolved or being an individual shall be adjudicated insolvent or shall make an assignment or a composition for the benefit of the greater part, in number of amount of his creditors or shall enter into a Deed or arrangement with his creditors, or if the Official Assignee in insolvency, or the Receiver of the contractor in insolvency, shall repudiate the contract, or if a Receiver of the contractor's firm appointed by the court shall be unable, within fourteen days after notice to him requiring him to do so, to show to the reasonable satisfaction of the employer that he is able to carry out and fulfill the contract, and if so required by the employer to give reasonable security therefore, or if the contractor shall suffer execution to be issued, or shall suffer any payment under this contract to be attached by or on behalf of any of the creditors of the contractor, or shall assign, charge or encumber this contract or any payments due or which may become due to the contractor there under, or shall neglect or fail to observe and perform all or any of the acts, matters or things by this contract to be observed and performed by the contractor within three clear days after the notice shall have been given to the contractor in manner hereinafter mentioned requiring the contractor to observe or perform the same or shall use improper materials or workmanship in carrying on the works, or shall in the opinion of the employer not exercise such due diligence and make such due progress as would enable the work to be completed within due time agreed upon, and shall fail to proceed to the satisfaction of the employer after three clear days' notice requiring the contractor so to do shall have been given to the contractor as hereinafter mentioned, or shall abandon the contract, then and in any of the said cases, the bank may notwithstanding previous waiver, determine the contract by a notice in writing to the effect as hereinafter mentioned, but without thereby effecting the powers of the contract the whole of which shall continue in force as fully as if the contract had not been so determined and as if the works subsequently executed had been executed by or on behalf of the contractor (without thereby creating any trust in favor of the contractor). Further the employer or his agent, or servants, may enter upon and take possession of the work and all plants, tools, scaffolding, sheds, machinery, steam and other power, utensils and materials lying upon premises or the adjoining lands or roads and sell the same as his own property or, may employ the same by means of his own servants and workmen in carrying on and completing the works or by employing any other contractors or other persons or person to complete the works, and the contractor shall not in any way interrupt or do any act, matter or thing to prevent or hinder such other contractor or other persons or person employed from completing and finishing the works. When the works shall be completed, or as soon thereafter as conveniently may be, the employer shall give notice in writing to the contractor to remove his surplus materials and plants and, should the contractor fail to do so within a period of 14 days after receipt by him, the employer may sell the same by Public Auction and shall give credit to the contractor for the amount so realized. Any expenses or losses incurred by the employer in getting the works carried out by other persons or agencies / contractors, the same shall be at the cost of contractor and adjusted against the amount payable to the contractor including by way of selling his tools and plants or due on account of work carried out by the contractor prior to engaging other persons or contractors or against the Security Deposit. This is without prejudice to any other legal recourse / claims if bank / employer be subject to greater financial loss and difficulties.

**42. Arbitration :** All disputes or differences of any kind whatsoever which shall at any time arise between the parties hereto touching or concerning the works or the execution or



·maintenance thereof of this contract or the rights touching or concerning the works or the execution of maintenance thereof of this contract or the construction remaining operation or effect thereof or to the rights or liabilities of the parties or arising out of or in relation thereto whether during or after determination foreclosure or breach of the contract (other than those in respect of which the decision of any person is by the contract expressed to be final and binding) shall after written notice by either party to the contract to the other of them and to the Employer hereinafter mentioned be referred for adjudication to a sole Arbitrator to be appointed as hereinafter provided.

For the purpose of appointing the sole Arbitrator referred to above, the Employer/Consultant Engineer will send within thirty days of receipt of the notice, to the contractor a panel of three names of persons who shall be presently unconnected with the organization for which the work is executed.

The contractor shall on receipt of the names of aforesaid, select any one of the persons named to be appointed as a sole Arbitrator and communicate his name to the Employer within thirty days of receipt of the names. The Employer shall there upon without any delay appoint the said person as the Sole Arbitrator. If the contractor fails to communicate such selection as provided above within the period specified, the competent authority shall make the selection and appoint the selected person as the Sole Arbitrator.

If the Employer/Consultant Engineer fails to send to the contractor the panel of three names as aforesaid within the period specified, the contractor shall send to the Employer a panel of three names of persons who shall all be unconnected with either party. The Employer shall on receipt of the named as aforesaid select anyone of the person's name and appoint him as the Sole Arbitrator. If the Employer fails to select the person and appoint him as the Sole Arbitrator within 30 days of receipt of the panel and inform the contractor accordingly, the contractor shall be entitled to appoint one of the persons from the panel as the Sole Arbitrator and communicate his name to the Employer.

If the Arbitrator so appointed is unable or unwilling to act or resigns his appointment or vacates his office due to any reason whatsoever another Sole Arbitrator shall be appointed as aforesaid. The work under the Contract shall, however, continue during the arbitration proceedings and no payment due or payable to the contractor shall be withheld on account of such proceedings. The Arbitrator shall give a separate reasoned award in respect of each dispute or difference referred to him. The venue of arbitration shall be such place as may be fixed by the Arbitrator in his sole discretion.

The fees and expenses, if any, of the Arbitrator shall, if required to be paid before the award is made and published, be paid half and half by each of the parties. The Arbitrator may direct to and by whom and in what manner the cost of the reference and of the award including the fees and expenses or any part thereof shall be paid and may fix or settle the amount of costs to be so paid.

The award of the Arbitrator shall be final and binding on both the parties. Subject to the aforesaid, the provisions of the Arbitration and Conciliation Act, 1996 or any statutory modification or re-enactment thereof and the rules made hereunder, and for the time being in force, shall apply to the arbitration proceeding under this clause.

The seat of arbitration will be at Kadapa subject to Kadapa Jurisdiction.

**43. Abnormally high and low rated items :** For item rate tenders if, the rates quoted by the lowest bidder for certain items of the Bill of Quantities of the tender are found to be abnormally high or low in comparison to the market rate analysis of the item done by the Consultant Engineer/Bank and or in comparison to Consultant Engineer/Bank's method of working out market rate justification for the items, the same shall be governed as under in order to avoid financial loss to the Bank in the event of default of contractors.

i) For abnormally high rated items (AHR), the progressive payment shall be 80% (eighty percent)





of the payment due to the contractor against execution of the AHR item. The balance withheld 20% payment shall be released after 75% of total value of the original contract is complete in financial terms or this 20% withheld payment can be released to the contractor on submission of an unconditional bank guarantee of equivalent amount in the Proforma of Bank. Further deviation limit for AHR items shall be nil on plus side and Bank reserves the right to restrict, substitute or not execute the AHR items during execution. The decision of the Consultant Engineer in this regard shall be final and binding on the contractor.

- ii) For abnormally low rated (ALR) items, the contractor shall submit Bank Guarantee of difference in total of amount of ALR item(s) and the total amount of corresponding items at market rate of the Consultant Engineer/Bank. This bank guarantee shall be valid till completion of the project. In exceptional circumstances, the amount of Bank Guarantees (BG) may be reduced or BG released earlier than completion period if, in view of Consultant Engineer, all ALR items as provided in the contract are executed as per terms of contract and/or not required to be executed.

Notwithstanding what is contained in para i) & ii) above, the provisions of para i) and ii) shall not be applicable on tenders invited on percentage rate basis.

The decision of the Consultant Engineer on identification/ marking of AHR and ALR item is final and binding on the contractor. In case the contractor do not agree for furnishing of Bank Guarantee as above towards ALR items, at the time of award of works, the EMD/Performance guarantee of the contractor shall be forfeited and decision of Consultant Engineer in this regard shall be final and binding on the contractor.

**44. Escalation :** The rates quoted shall be firm throughout the tenure of the contract (including extension of time, if any, granted) and will not be subject to any fluctuation due to increase in cost of materials, labour, all types of taxes etc.

**45.** The Successful bidder shall demolish the existing building and all materials rejected by the Bank's representative to be removed and disposed-off to approved dumping ground / area. Contractor's quoted rates shall be inclusive of the cost of this cleaning / clearing.



## SAFETY CODE

### **Scaffolds**

- i) Suitable scaffolds shall be provided for workmen for all works that cannot safely be done from the ground, or from solid construction except in the case of short duration work, which can be done safely from ladders. When a ladder is used, it shall be of rigid construction made either of good quality wood or steel. The steps shall have a minimum width of 450 mm and a maximum rise of 300 mm. Suitable hand holds of good quality wood or steel shall be provided and the ladder shall be given an inclination not steeper than  $\frac{1}{4}$  to 1 ( $\frac{1}{4}$  horizontal and 1 vertical).
- ii) Scaffolding or staging more than 4 m. above the ground floor, swung or suspended from an overhead support or erected with sanitary support shall have a guard rail properly bolted, braced or otherwise secured, at least 1 m. above the floor or platform of such scaffolding or staging shall be so fastened as to prevent it from swaying from the building or structure.
- iii) Working platforms, gangways and stairways shall be so constructed that they do not sag unduly or unequally and if the height of the platform, gangway or stairway is more than 4 m above ground level or floor level, they shall be closely boarded and shall have adequate width and be suitably fenced as described in (ii) above.
- iv) Every opening in the floor of a building or in a working platform with suitable means to prevent the fall of persons or materials or railing whose minimum height shall be 1.00m. Whenever there are open excavations in ground, they shall be fenced off by suitable railing and danger signals installed at night so as to prevent persons slipping into the excavations.
- v) Safe means of access shall be provided to all working places. Every ladder shall be securely fixed. No portable single ladder shall be over 9 m. in length while the width between side rails in rung ladder shall in no case, be less than 290 mm, for ladder up to and including 3m in length. For longer ladders this width shall be increased at least 20 mm for each additional meter of length.
- vi) A sketch of the ladders and scaffolds proposed to be used shall be prepared and approval of the Engineer obtained prior to construction.

### *Other Safety Measures*

- vii) All personnel of the contractor working within the plant site shall be provided with safety helmets. All welders shall wear welding goggles while doing welding work and all metal workers shall be provided with safety gloves. Persons employed on metal cutting and grinding shall wear safety glasses.
- viii) Adequate precautions shall be taken to prevent danger from electrical equipment. No materials on any of the sites of work shall be so stacked or placed as to cause danger or inconvenience to any person or the public.

### **Demolition**

- ix) Before any demolition work is commenced and also during the process of the work.
  - a) All roads open areas adjacent to the work site shall either be closed or protected.
  - b) No electric cable or apparatus, which is liable to be a source of danger over a cable or apparatus used by the operator, shall remain electrically charged.
  - c) All practical steps shall be taken to prevent danger to persons employed from the risk so over loaded with debris or materials as to render it unsafe.



**Personal Safety Equipment:** All necessary personal safety equipment as considered adequate by the Engineer should be kept available for the use of the person employed on the site and maintained in a condition suitable for immediate use, and the contractor should take adequate steps to ensure proper use of equipment by those concerned.

- a) Workers employed on mixing asphaltic materials, cement and lime mortars shall be provided with protective footwear and protective goggles.
- b) Those engaged in white washing and mixing or stacking of cement bags or any materials, which are injurious to the eyes, shall be provided with protective goggles.
- c) Those engaged in welding works shall be provided with welder's protective eyesight lids.
- d) Stonebreakers shall be provided with protective goggles and protective clothing and seated at sufficiently safe intervals.
- e) When workers are employed in sewers and manholes, which are in use, the contractor shall ensure that the manhole covers are opened and are ventilated at least for an hour before the workers are allowed to get into manholes and the manholes so opened shall be cordoned off with suitable railing and provided with warning signals or boards to prevent accident to the public.
- f) The contractor shall not employ men below the age of 18 years. Women of any age shall not be engaged for the work of painting with products containing lead in any form. Whenever men above the age of 18 years are employed on the work of lead painting the following precautions should be taken.
- g) No paint containing lead or lead products shall be used except in the form of paste or ready-made paint.
- h) Suitable facemasks should be supplied for use by the workers when paint is applied in the form of spray or a surface having lead paint dry rubbed and scraped.
- i) Overalls shall be supplied by the contractor to the workmen and adequate facilities shall be provided to enable the working painters to wash during the cessation of work.
- j) When the work is done near any public place where there is risk of accidents all necessary equipment's should be provided and kept ready for use and all necessary steps taken for prompt rescue of any person in danger and adequate provision should be made for prompt first aid treatment of all injuries likely to be sustained during the course of the work.

Witness

Signature of Contractor  
Address:



## APPENDIX: TIME SCHEDULE

- 1 Period of Completion : **270 DAYS\*** INCLUDING HOLIDAYS, SUNDAYS
- 2 Defects Liability Period (DLP) : 2 years (Two) from the date of Completion of work
- 3 Date of Commencement : From the date of acceptance of work order
- 4 Liquidated Damages for Delay : As mentioned in the Clause no.18
- 5 Period of final measurement : 45(Forty-five) days from the date of completion of work.
- 6 Value of work for Interim Certificate (Clause 32) : Minimum of Rs. 7.0 (Seven) lakhs
- 7 Period of honoring interim Certificate (Clause 32) : Total 15 working days.
- 8 Period of honoring Final Certificate (Clause 33) : 40 (Forty working Days) from the date of completion of work.
- 9 Retention Money (Clause 12) : 8% (Eight percent) of the Gross value of each interim/final bill shall be deducted as retention money
- 10 Total Security Deposit (Maximum) : As per clause no. 12 of general conditions of contract
- 11 Earnest Money Deposit : Rs. 30,000/- (Rupees Thirty Thousand Only)
- 12 Security Deposit including the Earnest Money Deposit : 2% (two percent) of the accepted value of the tender
- 13 Tender validity period : 270 days

\* 270 days is time of completion of the total project. Civil contractor to coordinate with Local Panchayath jurisdiction agencies and Local Electrical contractor and all the Civil works in the schedule to be completed within the overall project time of 270 days.

**SIGNATURE OF THE CONTRACTOR.**



## DRAFT FORMAT OF AGREEMENT

(TO BE ENTERED WITH SUCCESSFUL CONTRACTOR/ AGENCY IN STAMP PAPER)

This AGREEMENT is made at ..... on day of.....between Andhra Pragathi Grameena Bank having its Head Office, Kadapa, Andhra Pradesh State. (Hereinafter called "the Employer") on the ONE PART

AND

M/s. ----- duly represented by one of its Partner Sri. -----  
AGE: ... YEARS, S/O, ----- having their office at-----,  
(hereinafter called the Contractor) on the other part.

WHEREAS THE Bank is desirous of undertaking the **Bank owned Building demolition and construction at panchayath local @ V N Palli** as fully detailed in bill of quantities of the tender document and has accepted the tender opened on furnished by the contractor & the contractor has agreed to perform the services as set out and subject to the terms & conditions set forth in the said documents mentioned herein under.

NOW THIS AGREEMENT WITNESSETH as follows:

1. In this agreement words and expression shall have the same meanings as are respectively assigned to them in the conditions of contract hereinafter referred to.

2. The following documents not inconsistent with these presents shall be deemed to form and be read and construed as part of this agreement viz,

a) Notice inviting Tender

b) The Tender Document comprising; Tender Notice, General Conditions of the Contract, Special Conditions of Contract, preferred makes of materials, Schedule of quantities, Tender Drawings / Sketches.

c) Safety code.

d) Letter of Acceptance.

e) All Annexures

f) Letters from and to the Contractor, if any, leading to and prior to acceptance letter.

3. In consideration of the payments to be made by the Bank to the Contractor the Contractor hereby covenants and agrees with the Bank to construct, complete and perform the works in conformity in all respects and subject to all terms and conditions/rules as mentioned in the aforesaid documents which shall form part of this agreement.

In witness whereof, the parties here unto have set their respective hands and seals the day and year first above written.

For & on behalf of the  
Contractor with seal

For & on behalf of the  
APGB Bank with seal



DRAFT FORMAT OF INDEMNITY BOND  
(TO BE SUBMITTED BY THE SUCCESSFUL CONTRACTOR IN STAMP PAPER)

THIS DEED OF INDEMNITY BOND is made on this ----- day of ----- month of **2023**)  
By M/s \_\_\_\_\_, a company registered under Companies Act duly  
represented by one of its  
partners \_\_\_\_\_, aged \_\_\_\_\_ years, son of Sri \_\_\_\_\_,  
residing at \_\_\_\_\_.

Where I am the authorized partner of M/s \_\_\_\_\_), and had applied for tender of  
contractors for Civil works at **V N Palli PANCHAYATH VILLAGE KADAPA DISTRICT,**  
**ANDHRA PRADESH.**

Whereas M/s \_\_\_\_\_ was shortlisted for issue of tenders and my company  
became successful in securing through competitive tendering work of demolition and  
reconstruction of bank owned building situated at Panchayat local @ V N Palli and the same has  
been awarded in favor of my Firm/ company by APGB Bank, Head Office, KADAPA.

And whereas for undertaking the furnishing work, my company has entered into contract  
agreement on \_\_.\_\_.2023

Now this Deed Witnessed that in pursuance of the aforesaid contract agreement  
dt \_\_\_\_\_ and in consideration of APG Bank having agreed to make payments on the  
running bills claimed by my company based on the works completed by my company in respect  
of Construction of bank owned Building at **V N Palli Village Panchayat, Kadapa District** and  
referred to above,

**I hereby undertake to indemnify and keep harmless the APGB Bank & its project  
Consultant Engineer from any damages, prosecution, other legal suits and claims made  
by the employees/laborers arising out of any mishaps occurring at the site due to faulty  
work, faulty construction and for violating rules and regulations for which I shall be solely  
responsible.**

(SRI -----)

FOR M/S -----



**Bank Guarantee Format for Earnest Money Deposit**

To  
The General Manager  
PMS Dept.,  
APGB Bank, H.O  
KADAPA-516001.

WHEREAS \_\_\_\_\_(Name of Tenderer) (hereinafter called "the Tenderer" has submitted its tender dated \_\_\_\_\_(Date) for the execution of (Name of Contract) \_\_\_\_\_(hereinafter called "the Tender") in favour of **APGB BANK, \_\_\_\_\_**

"Beneficiary"; hereinafter called the

KNOW ALL MEN by these presents that we, \_\_\_\_\_(name of the issuing Bank), a body corporate constituted under the \_\_\_\_\_ having its Head Office at \_\_\_\_\_ amongst others a branch / office at \_\_\_\_\_(hereinafter called "the Bank" are bound unto the Beneficiary for the sum of Rs \_\_\_\_\_(Rupees \_\_\_\_\_ only) for which payment well and truly to be made to the said Beneficiary, the Bank binds itself, its successors and assigns by these presents;

THE CONDITIONS of this obligation are:

- (a) If the Tenderer withdraws its Tender during the period of Tender validity specified in the Tender; or
- (b) If the Tenderer having been notified of the acceptance of his Tender by the Beneficiary during the period of Tender validity;
  - (i) fails or refuses to execute the Agreement, if required; or
  - (ii) fails or refuses to furnish the performance security, in accordance with clause \_\_\_\_\_ of conditions of Contract.

We undertake to pay to the Beneficiary up to the above amount upon receipt of his first written demand without the Beneficiary having to substantiate his demand, provided that in his demand the Beneficiary will note that the amount claimed by him is due to him owing to the occurrence of one or both of the two conditions, specifying the occurred condition or conditions.  
Notwithstanding anything contained herein

- i) Our liability under this Bank Guarantee shall not exceed Rs. \_\_\_\_\_(Rupees \_\_\_\_\_ only)
- ii) This Bank Guarantee is valid up to \_\_\_\_\_ and
- iii) We are liable to pay the guaranteed amount or any part thereof under this Bank Guarantee only and only if you serve upon us a written claim or demand on or before \_\_\_\_\_(mention period of guarantee as found under clause (ii) above plus claim period)

Dated \_\_\_\_\_ day of \_\_\_\_\_ 2023  
SIGNATURE & SEAL OF THE BANK



**BANK GUARANTEE FORMAT FOR SECURITY DEPOSIT**

Guarantee No.....  
Amount of Guarantee Rs.....  
Guarantee cover from Dated: .....  
To Dated: .....  
Last Date for Lodgement of claim: .....

To:

\_\_\_\_\_  
\_\_\_\_\_  
\_\_\_\_\_

In consideration of ..... (hereinafter called "Beneficiary") having agreed to exempt ..... Ltd., having its Registered Office situated at ..... (hereinafter called the "the obligator(s)") from the demand of security deposit of Rs..... (Rupees ..... only) under the terms and conditions of an agreement dated ..... (hereinafter called the "said Agreement") for the due fulfillment by the said obligator of the terms and conditions contained in the said agreement, on production of the Bank Guarantee for Rs..... (Rupees ..... only), at the request of the obligator \_\_\_\_Bank, a body corporate constituted under the Banking Companies (Acquisition & Transfer of undertakings) Act, 1970 having its Head Office at \_\_\_\_amongst others a branch at ..... (hereinafter referred to as "the Bank") has agreed to give following guarantee in favour of the beneficiary for an amount \_\_\_\_\_ not exceeding \_\_\_\_\_ Rs..... (Rupees ..... only) against any loss or damage caused to or suffered or would be caused to or suffered by reason of any breach by the said Obligator(s) of any of the terms and conditions contained in the said agreement.

1. We, the Bank to hereby undertake to pay the amount payable under this guarantee without any demur merely on a demand from the beneficiary stating that the amount claimed is due by way of loss or damage caused to or would be caused to or suffered by reason or any breach of the terms and conditions contained in the said agreement or by reason of the obligator's failure to perform the said agreement. Any such demand in writing made on the Bank shall be conclusive as regards the amount due and payable by the Bank under the guarantee. However, our liability under this guarantee shall be restricted to an amount not exceeding Rs.....
2. We, the Bank further agree that the guarantee herein contained shall remain in full force and effect during the period that would be taken for the performance of the said agreement and that it shall continue to be enforceable till all the dues of the beneficiary under or by virtue of the said agreement have been fully paid and its claims satisfied or till the beneficiary certifies that the terms and conditions of the said agreement have been fully discharged this guarantee. Unless a demand for claim under this guarantee is made on us in writing on or before..... we shall be discharged from all liabilities under this guarantee thereafter.





3. We, the Bank further agree that the beneficiary shall have the fullest liberty, without consent and without effecting in any manner or obligations hereunder, to extend time of performance the said obligator(s) from time to time or to postpone for any time any of the powers exercisable by the beneficiary against the said obligator(s) and to for bear or enforce any of the terms and conditions relating to the said agreement and we shall not be relieved of our liability by reason of any extension being granted to the said obligator(s) for any forbearance, act or omission on the part of the beneficiary or any indulgence by the beneficiary to the said obligator(s) or by any such matter or thing whatsoever which under the law relating to sureties would not for this provision have effect of so relieving us.
4. We, the Bank lastly undertake not to revoke this guarantee during its currency except with the previous consent of the beneficiary in writing.
5. Notwithstanding anything contained herein:
  - (i) Our liability under this Bank Guarantee shall not exceed Rs. ....  
(Rupees ..... only)
  - (ii) This Bank Guarantee is valid up to..... and
  - (iii) We are liable to pay the guaranteed amount or any part there of under this Bank Guarantee only and only if you serve upon us a written claim or demand on or before (mention period of the guarantee as found under clause (ii) above plus claim period)

PLACE:  
DATE:

SIGNATURE



### APPROVED BRANDS & MATERIALS

Unless otherwise mentioned specifically, the contractor should get the approval of the Bank before using the materials. All makes/ brands shall be BIS marked wherever applicable and shall be of the First Quality. Wherever contractor proposes to use equivalent makes (i.e. other than specified), the same shall be done only after prior approval of the Bank. Any additional expenditure and time due to this shall be solely on contractor's account and no claims whatsoever shall be entertained.

SNo	Materials	Approved Make / Brands
<b>A</b>	<b>Civil works</b>	
1	Cement	P.P.C/ O.P.C. Grade 43/53 Ultra tech,Birla, ACC,jk,Bharathi, Priya
2	Bricks	MODULAR TABLE Moulded bricks of any brand.
3	Syporex brick blocks	Shirke or equivalent
4	Polymer Latex, Rust Removers, Rust PassivatorPlasticiser, Bonding solution and Crack filler	Fosroc, M.C. Bauchemie, Krishna Con chem., Pidilite
5	Waterproofing compound	Fosroc, M.C. Bauchemie, Krishna Con chem, Pidilite
6	White Cement	Birla, J.K. White
7	Wall putty	Biral, J.K.
8	G.I. pipes	Tata 'C' class only
9	CPVC/ UPVC pipes	Finolex, Astra, Supreme
10	G.I. fittings	R brand, Zoloto, Unique
11	Fixtures for CPVC/ UPVC pipes	Finolex, Astra, Supreme
12	Cement based paint	Snowcem, Nitcocem
13	Acrylic paint	Asian paints Apex, Snowcryl XT
14	Enamel paint/ OBD	Asian, Nerolac, berger
15	Tiles/ vitrified tiles	Johnson, RAK, Kajaria
16	Ceramic tiles	Johnson, Kajaria, RAK
17	Sanitary ware	Hindware, Parryware
18	Plumbing fixtures	Jaguar - Continental or equivalent in Marc
19	Stainless Steel Sink	Hindware, Nirali, Butterfly, Parryware, Frankie



## BILL OF QUANTITIES

The bill of quantities shall be read in conjunction with the drawings, Conditions of and Specifications as these documents are jointly explanatory and descriptive of the works included in the Contract. General directions and descriptions of work and materials given elsewhere in the Contract documents are not necessarily repeated in the Bill of Quantities, reference is to be made to the other documents for information.

The Quantities of work and material in the Bill of Quantities are not to be considered as limiting or extending the scope of work to be done and materials to be supplied by the contractor. The quantities in the Bill of Quantities are an estimate of the amount of work but the work will be measured on complete and the contractor will be paid on the actual measurement of work approved by the Engineer.

Where price have been entered against Lump sum items, payment for such affected items shall be made in proportion to the extent of which at the time of billing, works have been done at the discretion of the Engineer.

'Providing and Fixing' / 'Providing and Laying' / Providing and Erecting' shall mean that the contractor has to provide such materials not being procured and borne by the Employer, but which are required for the item and if no material need be provided by the Contractor, the rate shall be on for fixing/ laying/ erecting of the component covered in the item.

The work also includes separating and stacking serviceable material anywhere in the compound as directed and lowering and carting away all unserviceable material debris from the site.

The acronyms used in the Bill of Quantities.

SQM/sqm	Square meter
m/r.m	Running meter
Kg.	Kilogram
LS	Lump sum
Nos./ No	Numbers
Consultant Engineer/ consultant	Consultant Engineer



**FORMAT FOR RATE ANALYSIS OF EXTRA / NON TENDERED ITEMS**

I.	MATERIAL		
	1. Basic Cost of Material	-	Rs. _____
	2. Wastage – 5%	-	Rs. _____
II.	Labor: As per Standard	-	Rs. _____
	Labor output and labor input required for the Particular item using quoted labor rates.		
III.	Machinery / Tools	-	Rs. _____
	Inputs of Machinery / Tools requirements as per the item and hire charges as per market.		
	<b>TOTAL (I) + (II) + (III)</b>		_____
	Tax Liability		
	[as per contractual clauses will be added]	-	Rs. _____
V.	Add – ½ % for water charges	-	Rs. _____
	½ % for Electricity	-	Rs. _____
VI	Any other <b>Expenditure</b> (please specify)		
	<b>TOTAL</b>		_____
	Contractor Profit & OH – 15%	-	Rs. _____
	<b>GRAND TOTAL</b>	-	Rs. _____

TDS will be deducted as per standard norms.



# PLAN OF VN PALLI APGB

CARPET AREA

38' \* 40'  
1520 SFT

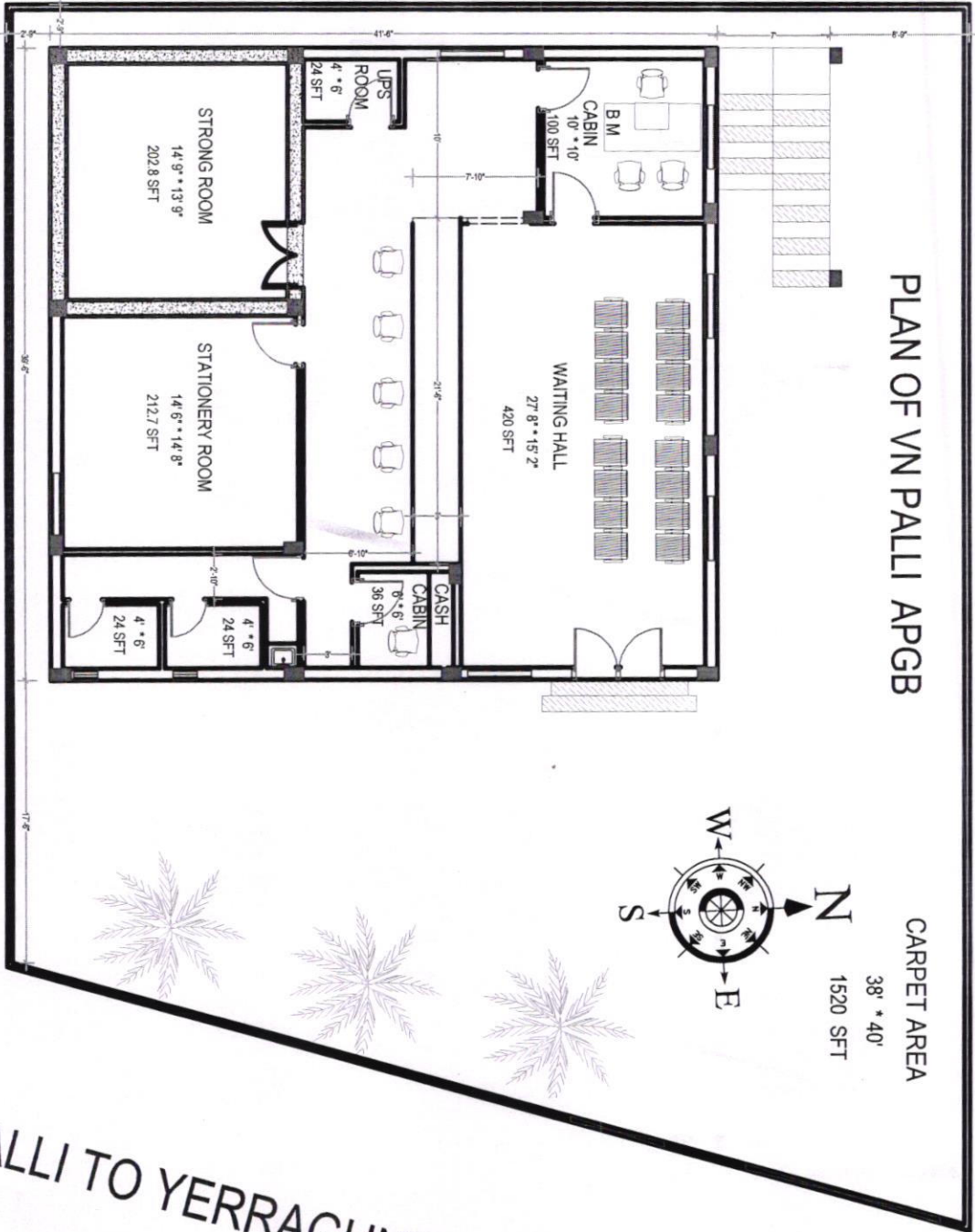
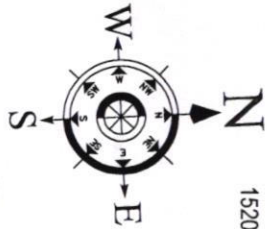

VEMPALLI TO YERRAGUNTLA MAIN ROAD



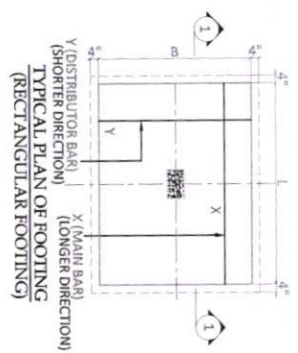
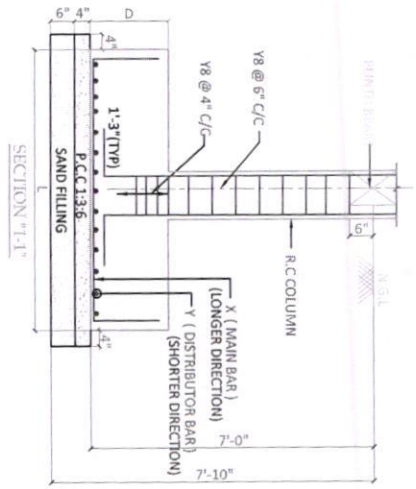

SCHEDULE OF FOOTINGS					
S NO	SIZE	NAME OF Lx X Lz	DEPTH	BOTTOM REINFORCEMENT	TOP REINFORCEMENT
1	F1	6'-0" x 4'-0" x 7'-0"	1'-2"	10# @ 6" C/C	10# @ 6" C/C
2	F2	10'-0" x 10'-0" x 7'-0"	1'-2"	10# @ 6" C/C	10# @ 6" C/C

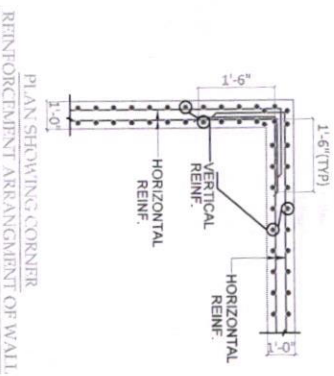
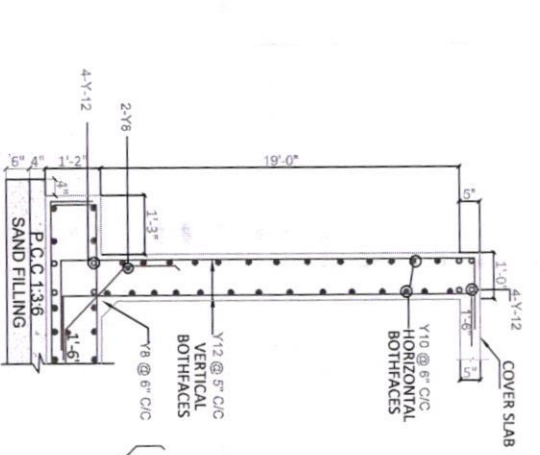
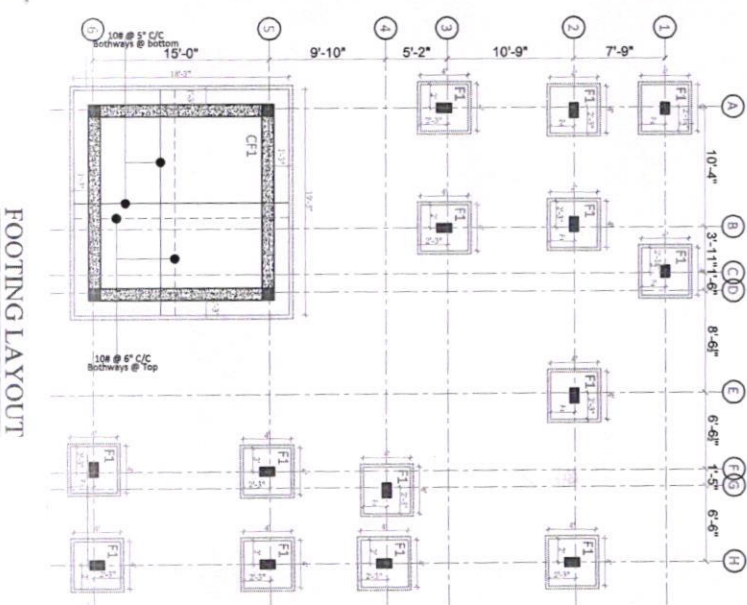

**Note:**  
1. This drawing should be read along with architectural drawings.  
2. Grade of R.C.C. items shall be M25 or (1:1:2) by design mix conforming to IS 456:2000 unless otherwise specified.  
3. Y Denotes TORQD Steel conforming to IS 1786 - 1985 Grade - Fx 500  
4. Chair cover to the main steel  
5. 2" for Footings, Rft Beam, Rft Slab.  
6. 1.5" for Columns.  
7. 1" for Plumb beam, Lintel & Beams.  
8. 0.5" for Staircase & Slab.  
9. Lap length shall be 50 d (Max dia) for all bars.  
10. Bottom Reinforcement  
11. Top Reinforcement  
12. Provide Continuous Chairs to keep the top Reinforcement in position  
13. Provide Y8 at 12" as Distribution steel for all top Reinforcement.  
14. Spacer Bar to be Provided in Between Two Layers of Reinforcement of Same Dia at Every 3'-0" C/C.  
15. Not more than 40% of Reinforcement shall be Lapped at any particular Junction.  
16. Structural is designed for GROUND FLOOR only  
17. S.B.C of Soil is taken as 250kg/m<sup>2</sup> at 7'-0" depth from N.G.L as per soil report.  
18. Cantilever props should not be released until the roof is concreted.  
19. Removal of formworks:  
a) for slabs:  
i) Slabs spanning upto 4.5 m (15'-0") - 7 days  
ii) Slabs spanning over 4.5 m (15'-0") - 14 days  
b) for beams and arches:  
c) Beams and arches spanning upto 6 m (20'-0") - 14 days  
d) Beams and arches spanning over 6 m (20'-0") - 21 days  
16. For all Window openings 2" Th. Sill Plate should be Provided at SILL LV with 12" Bearing on either side of opening.

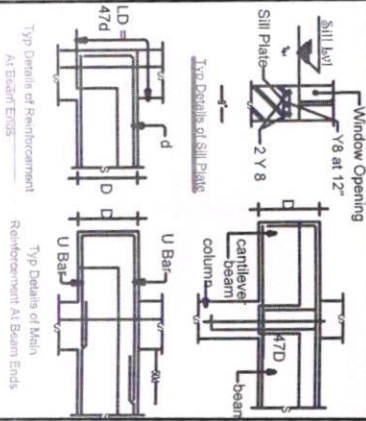

**FOOTING LAYOUT**



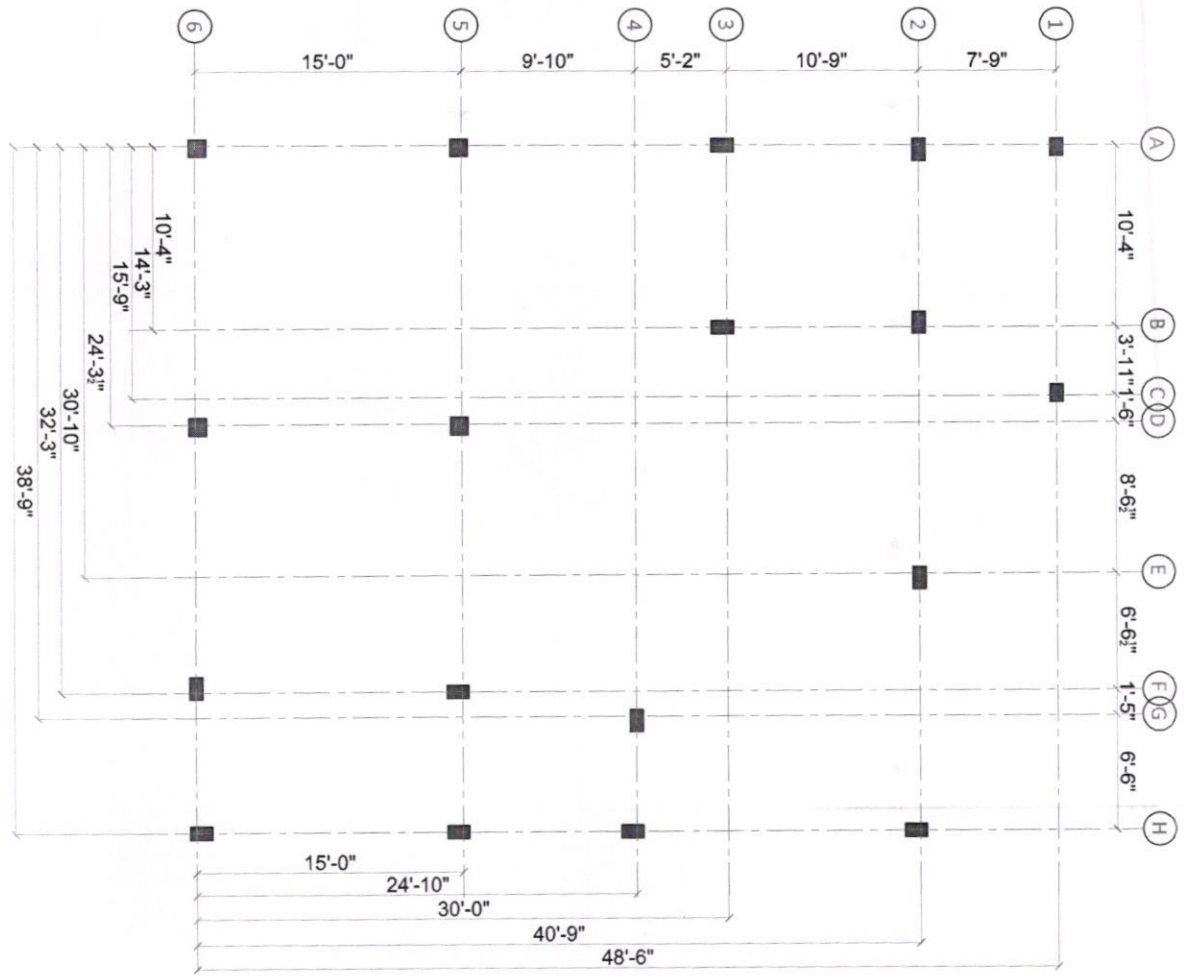

COLUMN CENTERLINE LAYOUT



Notes

1. This drawing should be read along with architectural drawings.
2. Grade of R.C.C. items shall be M25 or (1:1:2) by design mix conforming to IS 456:2000 unless otherwise specified.
3. Y Denotes TOR40 Steel conforming to IS 1786 - 1985 Grade - Fe 500
4. Clear cover to the main steel  
 Z" for Footings, Raft Beam, Raft Slab  
 1.5" for Columns.  
 1" for Pile beam, Lintel & Beams.  
 0.5" for Sunblinds & Slab
5. Lap length shall be 50 d (Max dia) for all bars.
6. Bottom Reinforcement
7. Top Reinforcement
8. Provide Continuous Chains to keep the top Reinforcement in position
9. Provide Y8 at 12" at Distribution steel for all top Reinforcement.
10. Spacer Bar to be Provided in Between Two Layers of Reinforcement of Same Dia at Every 3'-0" C/C. Lapped at any particular Junction.
11. Not more than 40% of Reinforcement shall be Structural is designed for GROUND FLOOR only
12. S.B.C of Soil is taken as 200kg/m<sup>2</sup> at 7'-0" depth from N.G.L as per soil report.
13. Cantilever props should not be released until the roof is concreted.
14. Removal of formwork:  
 i) for slabs:  
 a. Slabs spanning upto 4.5 m (15'-0") - 7 days  
 b. Slabs spanning over 4.5 m (15'-0") - 14 days  
 ii) for beams and arches:  
 c. Beams and arches spanning upto 6 m (20'-0") - 14 days  
 d. Beams and arches spanning over 6 m (20'-0") - 21 days
16. For all Window openings 2" Th Sill Plate Should be Provided at Sill Lvl with 12" Bearing on either side of opening.

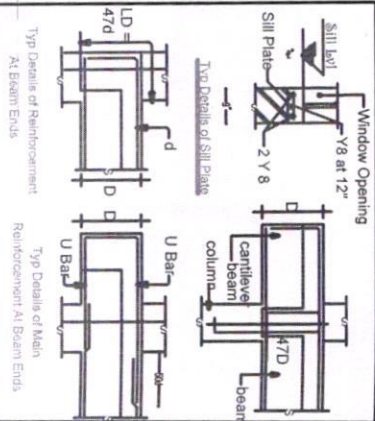

COLUMN CENTERLINE LAYOUT



# COLUMN LAYOUT

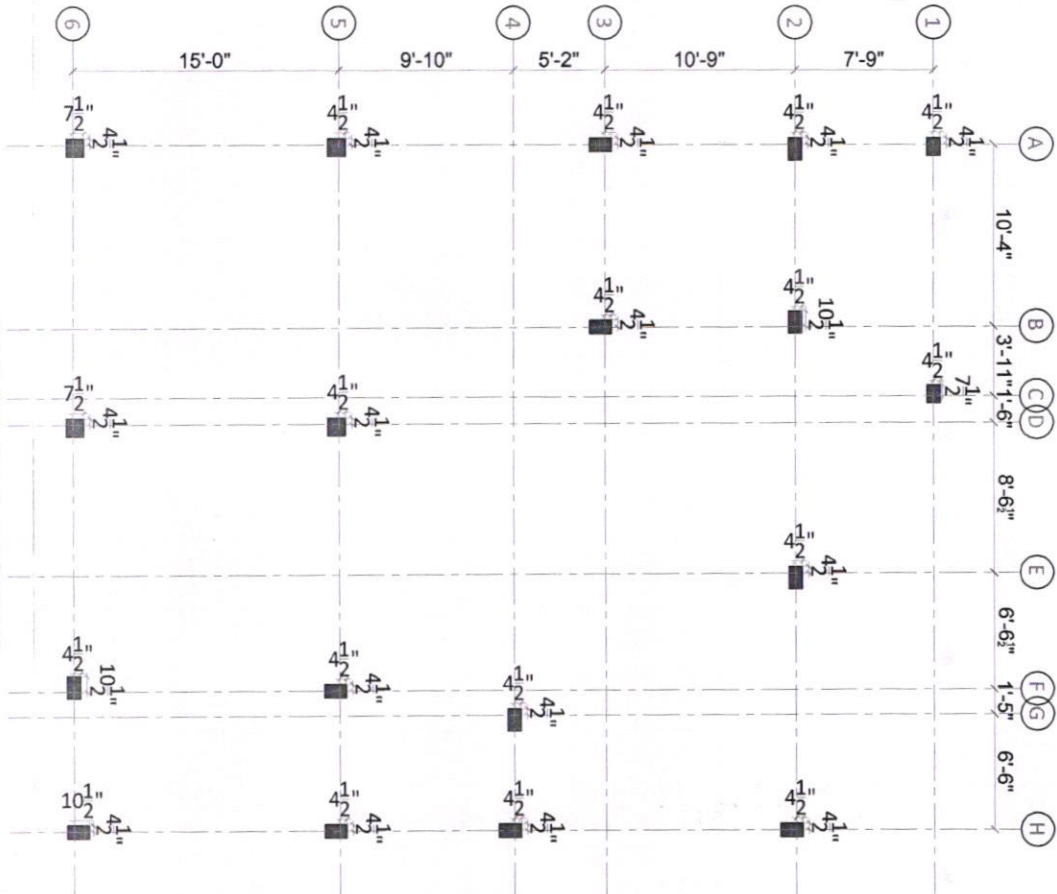

**Notes:**

1. This drawing should be read along with architectural drawings.
2. Grade of R.C.C. items shall be M25 or (1:1:2) by design mix conforming to IS 456-2000 unless otherwise specified.
3. Y Decks TOR40 Steel conforming to IS 1786 - 1985, Grade - Fa 500
4. Clear cover to the main steel
5. 2" for Footings, Rmt Beam, Rmt Slab.
- 1.5" for Column.
- 1" for Plinth beam, Lintel & Beams.
- 0.5" for Sunshade & Slab.
5. Lap length shall be 50 d (Max dia) for all bars.
6. Bottom Reinforcement
7. Top Reinforcement
8. Provide Continuous Chairs to keep the top Reinforcement in position
9. Provide Y8 at 12" as Distribution steel for all top Reinforcement.
10. Spacer Bar to be Provided in Between Two Layers of Reinforcement of Same Dia at Every 3'-0" C/C.
11. Not more than 40% of Reinforcement shall be Lapped at any particular junction.
12. Structural is designed for GROUND FLOOR only
13. S.B.C of Soil is taken as 298kg/m<sup>2</sup> at 7'-0" depth from N.G.L. as per soil report.
14. Cantilever props should not be released until the roof is concreted.
15. Removal of formworks:
  - i) for slabs:
    - a. Slabs spanning upto 4.5 m (15'-0") - 7 days
    - b. Slabs spanning over 4.5 m (15'-0") - 14 days
  - ii) for beams and arches:
    - c. Beams and arches spanning upto 6 m (20'-0") - 14 days
    - d. Beams and arches spanning over 6 m (20'-0") - 21 days
16. For all Window openings 2" Th Sill Plate Should be Provided at Sill Lvl with 12" Bearing on either side of opening.

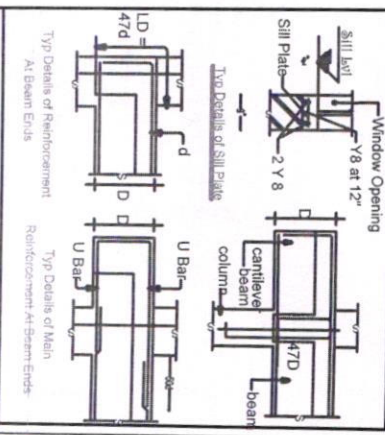

# COLUMN LAYOUT

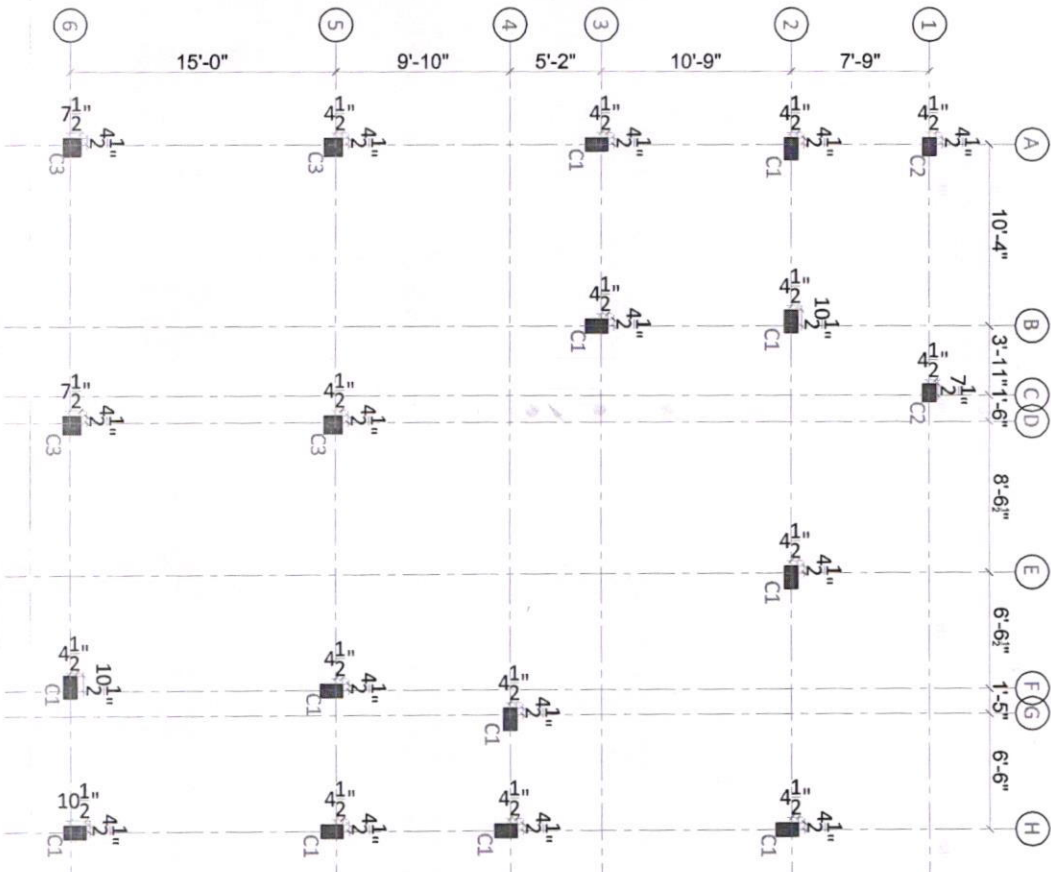

**COLUMN LAYOUT**

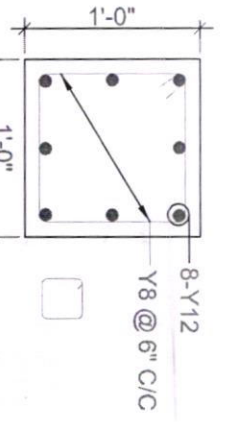

CS OF COLUMN "C3"  
(1'-0" x 1'-0")

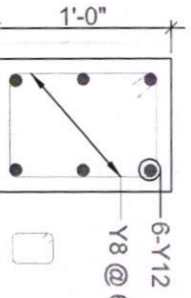

CS OF COLUMN "C2"  
(0'-9" x 1'-0")

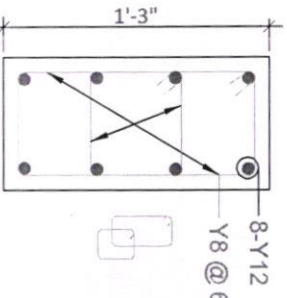

CS OF COLUMN "C1"  
(0'-9" x 1'-3")

**DETAIL OF COLUMN SHOWING LINK SPACING**

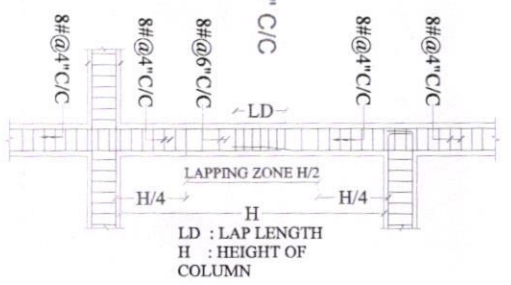
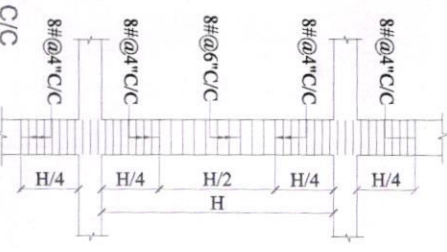

**THE SPACING DETAILS AT JUNCTION OF COLUMN & BEAM**

LD : LAP LENGTH  
H : HEIGHT OF COLUMN

**Notes**

1. This drawing should be read along with architectural drawings.
2. Grade of R.C. items shall be M25 or (1:1:2) by design mix conforming to IS-456-2000 unless otherwise specified.
3. Y Denotes TORQ40 Steel conforming to IS: 1786 - 1985, Grade - Fa 500
4. Clear cover to the main steel
5. 2" for Footings, Rest Beam, Rest Slab, 1.5" for Columns, 1" for Plinth beam, Lintel & Beams, 0.5" for Sunshade & Slab
6. Lap length shall be 50 d (Max. dia) for all bars.
7. Top Reinforcement
8. Provide Continuous Chains to keep the top Reinforcement in position
9. Provide Y8 at 12" as Distribution steel for all top Reinforcement
10. Spacer Bar to be Provided in Between Two Layers of Reinforcement of Same Dia at Every 3-0" C/C.
11. Not more than 40% of Reinforcement shall be Lapped at any particular Junction
12. Structural is designed for GROUND FLOOR only
13. S.D.C of Soil is taken as 280kg/m<sup>2</sup> at 7-0' depth from N.G.L. as per soil report
14. Cantilever props should not be released until the roof is concreted
15. Removal of formworks :  
i) for slabs :  
a. Slabs spanning upto 4.5 m (15'-0") - 7 days  
b. Slabs spanning over 4.5 m (15'-0") - 14 days  
ii) for beams and arches :  
c. Beams and arches spanning upto 6 m (20'-0") - 14 days  
d. Beams and arches spanning over 6 m (20'-0") - 21 days
16. For all Window openings 2" Th Sill Plates Should be Provided at Sill Lvl with 12" Bearing on either side of opening.

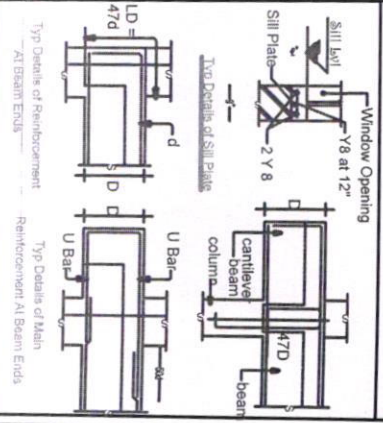

**COLUMN LAYOUT**

Typ Details of Reinforcement  
At Beam Ends  
Reinforcement At Beam Ends

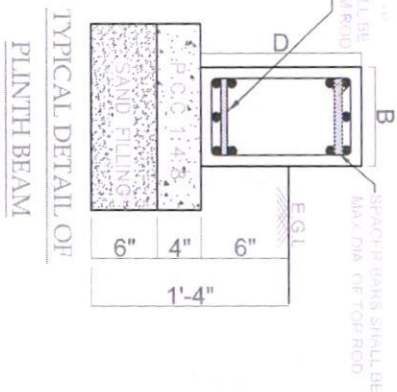
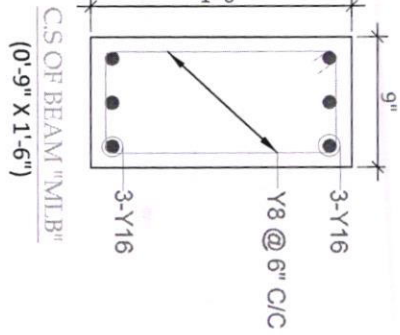

TYPICAL DETAIL OF PLINTH BEAM



TYP. DETAIL OF STAIRCASE DOWELS

FLIGHT-II

FLIGHT-I



**Note:**

1. This drawing should be read along with architectural drawings.
2. Grade of R. C. Bars shall be M25 or (1:1.5:2) by design mix conforming to IS:456-2000 unless otherwise specified.
3. Y Denotes TOR40 Steel conforming to IS: 1786 - 1985 Grade - Fe 500
4. Clear cover to the main steel 2" for Footings, Ret. Beam, Ret. Slab, 1.5" for Columns, 1" for Plinth beam, Lintel & Beams, 0.5" for Surchade & Slab.
5. Lap length shall be 50 d (Max dia) for all bars.
6. Bottom Reinforcement
7. Top Reinforcement
8. Provide Continuous Chains to keep the top Reinforcement in position
9. Provide Y8 at 12" as Distribution steel for all top Reinforcement.
10. Spacer Bar to be Provided in Between Two Layers Of Reinforcement of Same Dia at Every 3-0" C/C.
11. Not more than 40% of Reinforcement shall be Lapped at any particular Junction.
12. Structural is designed for GROUND FLOOR only
13. S.B. C of Soil is taken as 250kg/m<sup>2</sup> at 7-0" depth from N.G.L. as per soil report.
14. Cantilever props should not be released until the roof is concreted.
15. Removal of formworks :  
i) for slabs :  
a. Slabs spanning upto 4.5 m (15-0") - 7 days  
b. Slabs spanning over 4.5 m (15-0") - 14 days  
ii) for beams and arches :  
c. Beams and arches spanning upto 6 m (20-0") - 14 days  
d. Beams and arches spanning over 6 m (20-0") - 21 days
16. For all Window openings 2" Th. Sill Plate Should be Provided at Sill Lvl with 12" Bearing on either side of opening

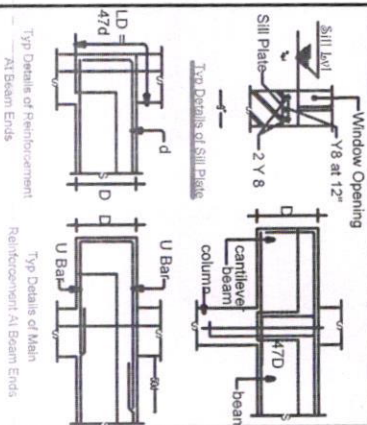

Typ Details of Reinforcement At Beam Ends

Typ Details of Main Reinforcement At Beam Ends

STAIRCASE DETAILS



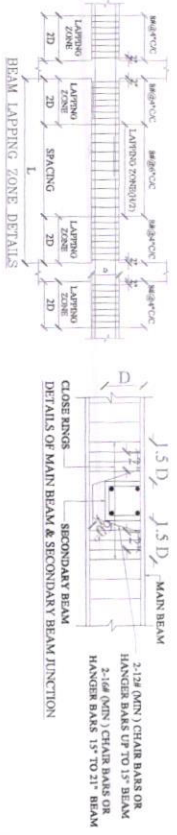

**GROUND FLOOR ROOF BEAM LAYOUT**

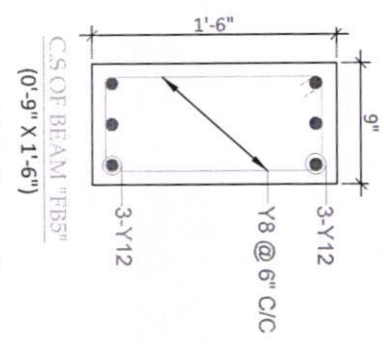
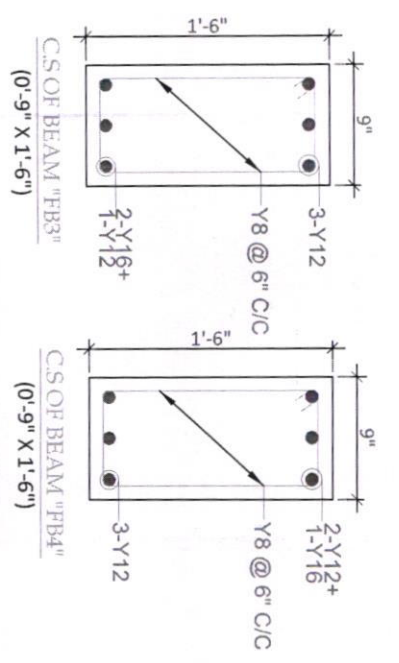
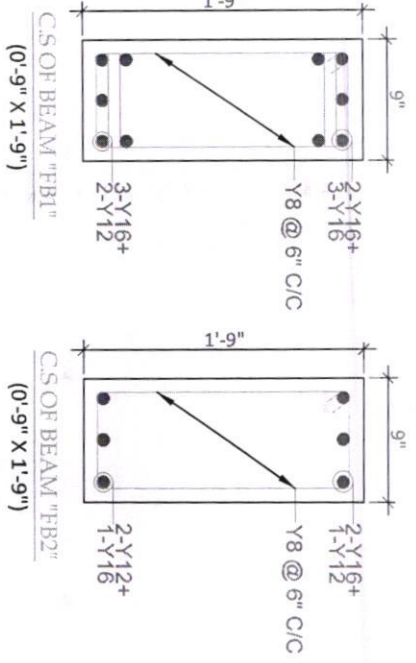
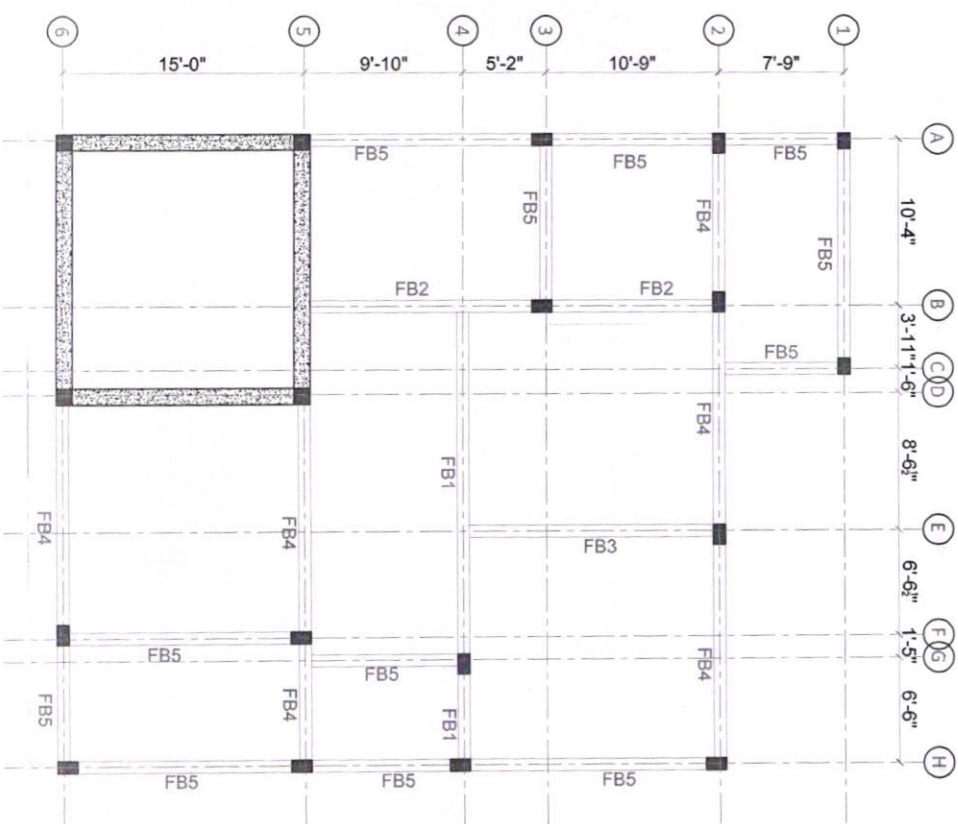

- Note:**
- This drawing should be read along with architectural drawings.
  - Grade of R.C.C. items shall be M25 or (1:1:2) by design mix conforming to IS 456:2000 unless otherwise specified.
  - Y denotes TORQO Steel conforming to IS 1786 - 1985 Grade - Fa 500
  - Clear cover to the main steel Z" for Footings, Rest Beam, Rest Slab, 1.5" for Columns, 1" for Plinth beam, Lintel & Beams, 0.5" for Surchals & Slab
  - Lap length shall be 50 d (Max dia) for all bars.
  - Bottom Reinforcement
  - Top Reinforcement
  - Provide Continuous Chairs to keep the top Reinforcement in position
  - Provide Y8 at 12" as Distribution steel for all top Reinforcement.
  - Spacer Bar to be Provided in Between Two Layers of Reinforcement of Same Dia at Every 3-0" C/C.
  - Not more than 40% of Reinforcement shall be Lapped at any particular junction.
  - Structural is designed for GROUND FLOOR only
  - S.B.C of Soil is taken as 28kg/m<sup>2</sup> at 7-0" depth from N.G.L as per soil report.
  - Canthelver props should not be released until the roof is concreted.
  - Removal of formworks :
    - for slabs :
      - Slabs spanning upto 4.5 m (15-0") - 7 days
      - Slabs spanning over 4.5 m (15-0") - 14 days
    - for beams and arches :
      - Beams and arches spanning upto 6 m (20-0") - 14 days
      - Beams and arches spanning over 6 m (20-0") - 21 days
  - For all Window openings 2" Th Sill Plate Should be Provided at Sill LV with 12" Bearing on either side of opening.

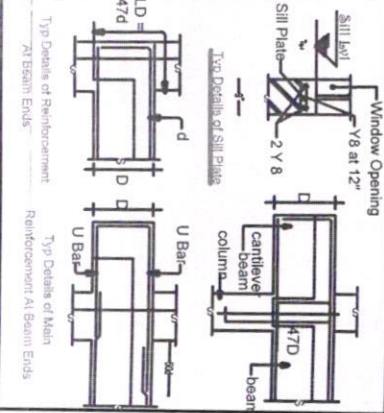

**GFR BEAM LAYOUT**

ANDHRA PRAGATHI GRAMINA BANK \* P.M.S.D. \* H.O. KADAPA

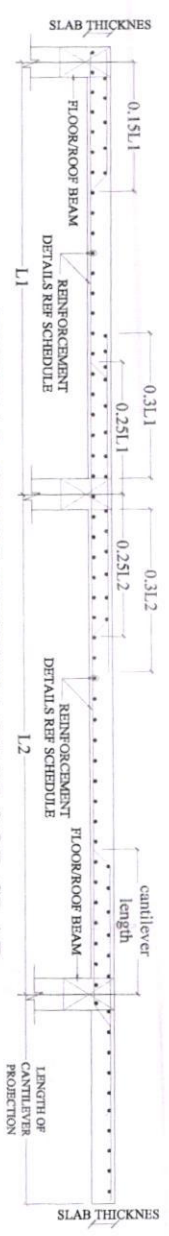

TYPICAL CROSS SECTION OF FLOOR SLAB

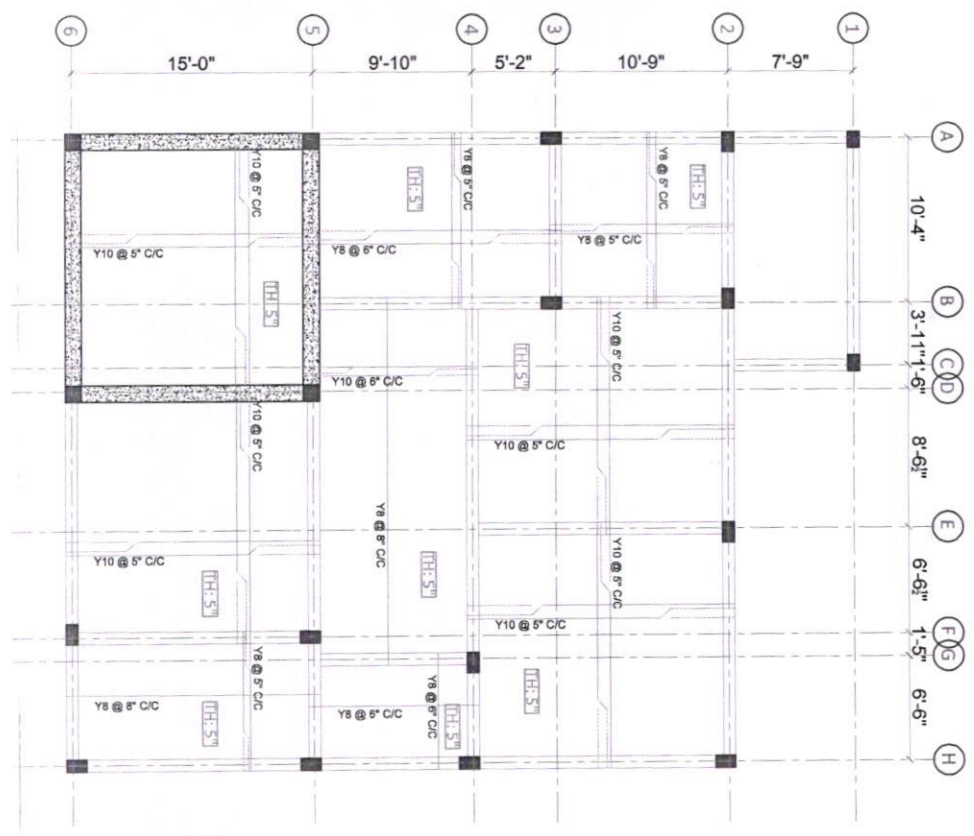

GROUND FLOOR ROOF SLAB LAYOUT

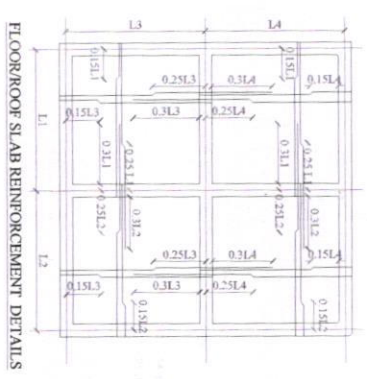

FLOOR/ROOF SLAB REINFORCEMENT DETAILS



**Note:**  
1. This drawing should be read along with architectural drawings.

2. Grade of R.C.C. items shall be M25 or (1:1.2) by design mix conforming to IS 456:2000 unless otherwise specified.

3. Vertical Reinforcement shall conforming to IS 1786 - 1985 Grade - Fe 500

4. Clear cover to the main steel 2" for Footings, Ret. Beam, Ret. Slab, 1.5" for Columns, 1" for Pile/b. beam, Lintel & Beams, 0.5" for Stanchion & Sash.

5. Lap length shall be 50 d (Max dia) for all bars.

6. Top Reinforcement Bottom Reinforcement

7. Provide Continuity Chains to keep the top Reinforcement in position

8. Provide Y8 at 12" as Distribution steel for all top Reinforcement.

9. Spacer Bar to be Provided in Between Two Layers of Reinforcement of Same Dia at Every 3'-0" C/C.

10. Not more than 40% of Reinforcement shall be Lapped at any particular junction.

11. Structural is designed for GROUND FLOOR only

12. S.B.C of Soil is taken as 298kg/m<sup>2</sup> at 7'-0" depth from N.G.L. as per soil report.

13. Cantilever props should not be released until the roof is concreted.

14. Removal of formworks:

15. for slabs:  
a. Slabs spanning upto 4.5 m (15'-0") - 7 days  
b. Slabs spanning over 4.5 m (15'-0") - 14 days

16. for beams and arches:  
a. Beams and arches spanning upto 6 m (20'-0") - 14 days  
b. Beams and arches spanning over 6 m (20'-0") - 21 days

17. For all Window openings 2" Th Sill Plate Should be Provided at Sill LV with 12" Bearing on either side of opening.

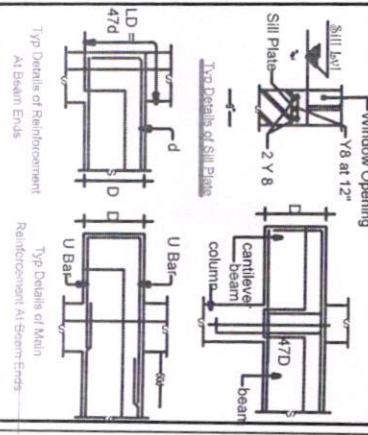

GFR SLAB LAYOUT

### LINTEL BEAM DESIGN

Opening Size	Reinforcement	Opening Size	Reinforcement	Opening Size	Reinforcement
UP TO 3'-0" OPENING	#8- 4 Nos 4.5" x 5"	3'0" - 5'0" OPENING	#10- 4 Nos 4.5" x 6"	5'0" - 7'0" OPENING	#12- 4 Nos 4.5" x 9"
4.5" THK WALL	#8- 4 Nos 4.5" x 5"	3'0" - 5'0" OPENING	#10- 2 Nos #12- 2 Nos 4.5" x 6"	5'0" - 7'0" OPENING	#10- 6 Nos #12- 4 Nos 4.5" x 9" 2L - Cut rod .7L - Mid Span Cut rod
9" THK WALL	#10- 4 Nos 5" x 9"	3'0" - 5'0" OPENING	#10- 2 Nos #12- 2 Nos 6" x 9"	5'0" - 7'0" OPENING	#10- 6 Nos #12- 4 Nos 6" x 9" 2L - Cut rod .7L - Mid Span Cut rod
9" THK WALL	#10- 4 Nos 5" x 9"	3'0" - 5'0" OPENING	#10- 2 Nos #12- 2 Nos 6" x 9"	5'0" - 7'0" OPENING	#12- 6 Nos #12- 4 Nos 6" x 9" 2L - Cut rod .7L - Mid Span Cut rod

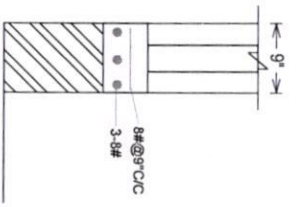

R.C.C Sill slab @  
Window Sill Level - 9"  
x 3"  
(8" Extra Two Sides Of  
Opening)

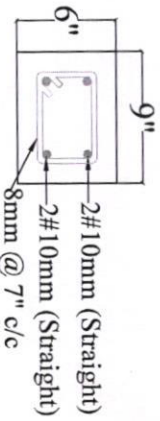

Continuous Lintel

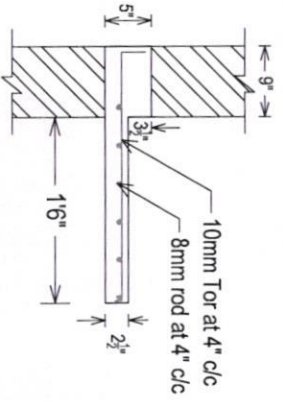

LOFT SLAB 1'6" / 2'0" LENGTH

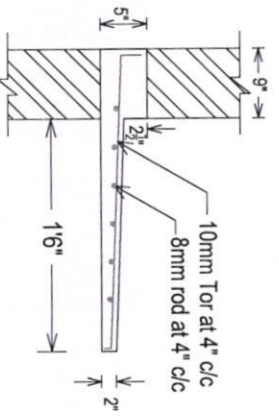

SUNSHADE 1'6" / 2'0" LENGTH

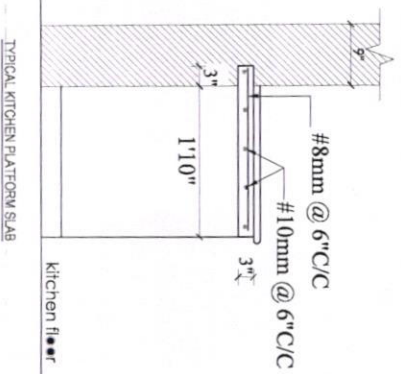

TYPICAL KITCHEN PLATFORM SLAB

Kitchen floor



### LINTEL DETAILS





